



modena



MANUEL DE L'UTILISATEUR USER MANUAL

Table des matières

Spécifications Techniques	3
Introduction	3
Dimensions	3
Réglementation	4
Garantie applicable en France	4
Consignes de sécurité	4
Spectrométrie	6
Raccordement DMX	9
Architecture des menus	10
Agencement des Pixels.....	16
Affectation des canaux	17

ENGLISH VERSION	38
------------------------------	-----------



SPÉCIFICATIONS TECHNIQUES :

- Zoom 4.35° - 32° beam (5°- 55° Field)
- Eclairage : 17000Lux à 5M/4.35°
- Flux max 3650 Lumens
- Refroidissement : Air forcé 3 modes
- Modes DMX : 15/19/21/25/41/69ch
- Protocoles : DMX/Artnet/sACN/Klingnet/RDM
- 20 programmes internes de patterns
- BColor System
- Flicker Free : Fréquence des leds ajustable de 9000 à 25000Hz
- Dmx In/Out connecteurs: 2 x XLR5.
- Artnet/ sACN/Klingnet connecteurs: 2 x RJ45
- Dimensions L x P x H : 256MM*180MM*334MM (hors poignées)
292MM*180MM*334MM (avec poignées)
- Poids net : 7.38Kg avec Omega d'accroche .
- Puissance max : 300W

Introduction :

Ce produit a été dédié à une utilisation en intérieur exclusivement. Particulièrement adapté pour les scènes. Plateau TV ou discothèques. Contrôlables en DMX ces projecteurs pourront être contrôlés par n'importe quelle console DMX.

DIMENSIONS (mm) :

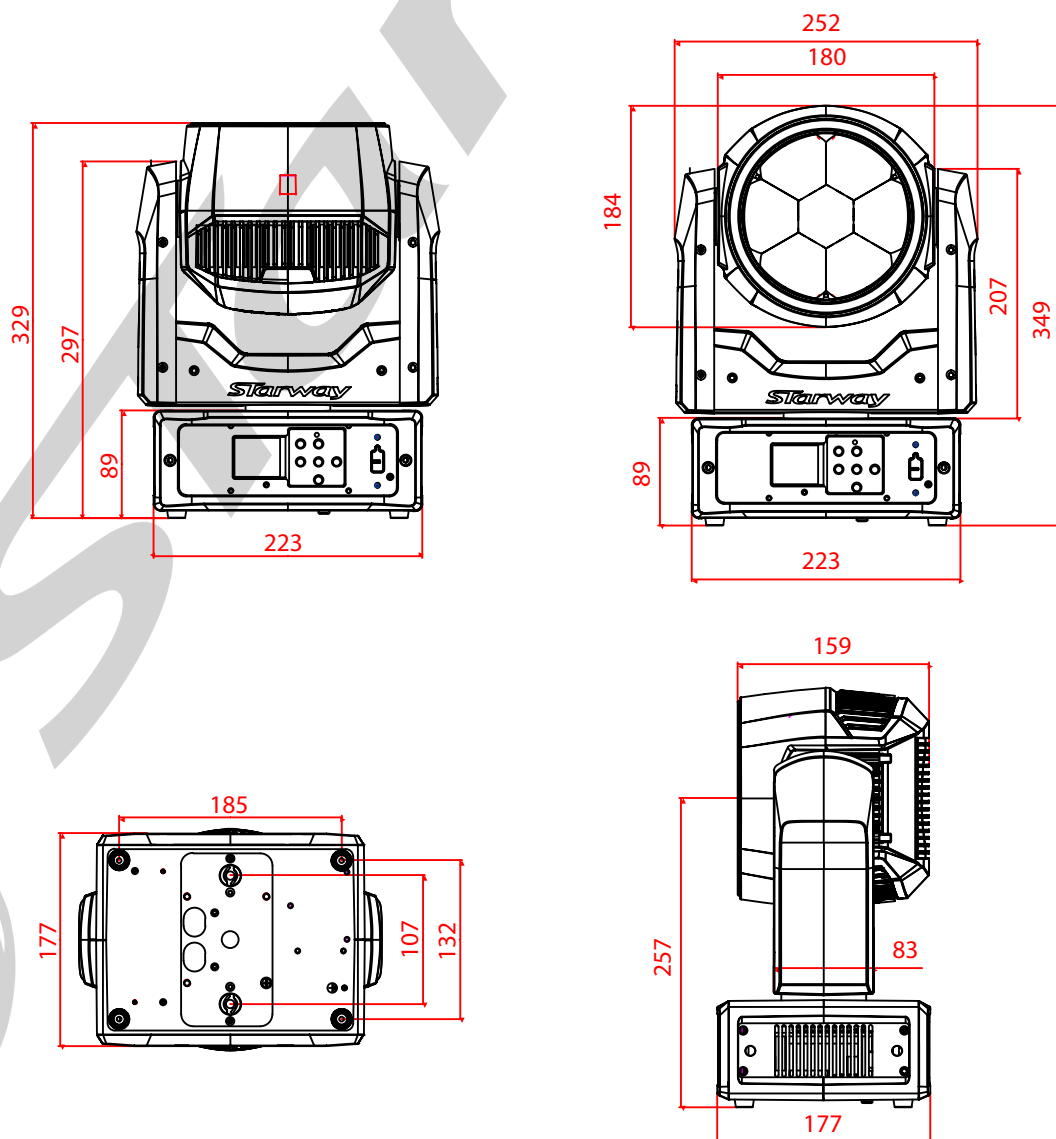

Réglementation

Cet appareil est parfaitement conçu. Il répond aux dispositions réglementaires actuelles : CE, ROHS, R&TTE

Recyclage

Appareil soumis à la DEEE (Collecte sélective). Contribuez à la protection de l'environnement en éliminant les matériaux d'emballage de ce produit via les filières de recyclage appropriées. Recyclez ce produit via une filière DEEE (déchets d'équipements électroniques). Ce produit doit être repris par votre revendeur ou doit être déposé dans un centre de collecte spécifique (déchetterie).

Garantie applicable en France

Le fabricant a apporté le plus grand soin à la conception et à la fabrication de votre produit pour qu'il vous apporte entière satisfaction. Néanmoins, s'il apparaissait que votre produit était défectueux, vous bénéficiez d'une garantie commerciale de 24 mois à compter de la date d'achat. Pour mettre en œuvre cette garantie, l'utilisateur doit présenter le produit au distributeur, accompagné du ticket de caisse ou la facture d'achat accompagnée du numéro de série.

Cette garantie, applicable en France, couvre tous les défauts du produit qui ne permettent pas une utilisation normale du produit. Elle ne couvre pas les défauts liés à un mauvais entretien, une utilisation inappropriée, une usure prévisible ; ou si les recommandations du fabricant n'ont pas été respectées.

La garantie ne couvre pas l'usure normale des pièces liée à l'utilisation du produit, tel que Batterie, Lampe, Roues, pièces d'usures, etc...

Eu égard au défaut et à la pièce concernée, le garant décidera alors de procéder à la réparation ou au remplacement de ladite pièce.

Le garant est : **CSI AUDIOVISUEL - 22 Rue Edouard Buffard - 75144 Montevrain - 01.48.63.22.11.**

La durée de fourniture de pièces détachées est de deux ans.

La garantie commerciale prévue ci-dessus ne limite aucunement le droit de l'acheteur d'agir en garantie des vices cachés ou de non-conformité, tel que prévu aux codes civil et de la consommation Française.

Consignes de sécurité

VEUILLEZ LIRE ATTENTIVEMENT ET CONSERVEZ CE MANUEL

Toute personne impliquée dans l'installation, l'utilisation et la maintenance de cet appareil doit être qualifiée et suivre les instructions comprises dans ce manuel.

Soyez prudent risques de chocs électriques !

Avant la mise en fonction, soyez certain que le produit n'ait pas subi de dommage durant le transport. Dans le cas contraire, contactez votre revendeur.

Afin de maintenir l'appareil en parfaites conditions, l'utilisateur doit suivre les instructions de sécurité et d'utilisation décrites dans ce présent document.

Notez que les dysfonctionnements liés à la modification de l'appareil ne sont pas couverts par la garantie.

Cet appareil ne contient aucune partie remplaçable par l'utilisateur, pour toute intervention contactez votre revendeur.



Soyez prudent risque photo-biologique !
Attention !! Système d'éclairage professionnel
ne pas regarder le flux lumineux dans l'axe.



Risque d'incendie maintenir une distance minimale de 0,8 m entre le faisceau et une surface inflammable.

IMPORTANT :

Cet appareil doit être utilisé en intérieur avec une température ambiante inférieure à 40°. Fixer le projecteur d'une façon stable.

Ne pas faire cheminer le câble d'alimentation avec les autres câbles.

Manipuler le câble d'alimentation avec les précautions d'usage.

Ne pas insérer d'objets dans les aérations.

Ne pas démonter ou modifier l'appareil. Risque d'électrocution !

Ne pas connecter cet appareil à un bloc de puissance.

Ne pas mettre En / Hors fonction de manière répétée.

Cet appareil doit être relié à la terre

N'utiliser cet appareil qu'après vous être familiarisé avec ses commandes et fonctions.

Éviter tout contact avec les flammes, éloignez l'appareil des surfaces inflammables.

Laisser toujours un espace suffisant autour de l'appareil pour permettre sa convection.

Déconnecter l'appareil du secteur, lorsqu'il n'est pas utilisé ou avant de le nettoyer.

Toujours débrancher l'alimentation en tenant la prise secteur et non le câble.

Vérifier que le cordon d'alimentation ne soit ni pincé ni endommagé, (prises et câbles)

Si l'appareil est tombé ou à reçu un choc, déconnecter le immédiatement du secteur et contacter un technicien qualifié pour le vérifier.

Si l'appareil a été soumis à d'importantes fluctuations de température, ne le mettez pas en fonction immédiatement, la condensation pourrait l'endommager en créant un CC (court-circuit).

Si l'appareil ne fonctionne pas correctement, mettez-le hors fonction immédiatement. Emballer-le, (de préférence dans son emballage d'origine).

Ce produit doit être utilisé exclusivement par un adulte en bonne santé.

Il doit être installé hors de portée des enfants.

Ne jamais utiliser le produit sans surveillance.

Ne pas utiliser l'appareil dans des zones ATEX ou et à proximité de d'hydrocarbure ou de produit inflammable.

Cet appareil doit être utilisé conformément à ce manuel, pour éviter tous dysfonctionnement

Nettoyage

Penser à nettoyer régulièrement l'optique avec un chiffon micro-pore.

L'usage d'air comprimé permet de nettoyer le boîtier.

**Le projecteur doit être sécurisé
par une élingue de sécurité**



SPECTROMÉTRIE

Distance 5 mètres		
Couleur	Longueur d'onde	Lux
Rouge	637 nm	3006 lux
Vert	516 nm	6309 lux
Bleu	443 nm	1192 lux
Blanc		8000 lux
LEDs RGWB 4.35°		17090 lux
LEDs RGWB 32°		460 lux

MESURES EFFECTUÉES AVEC *USPECTRUM MK305S*

LED ROUGE

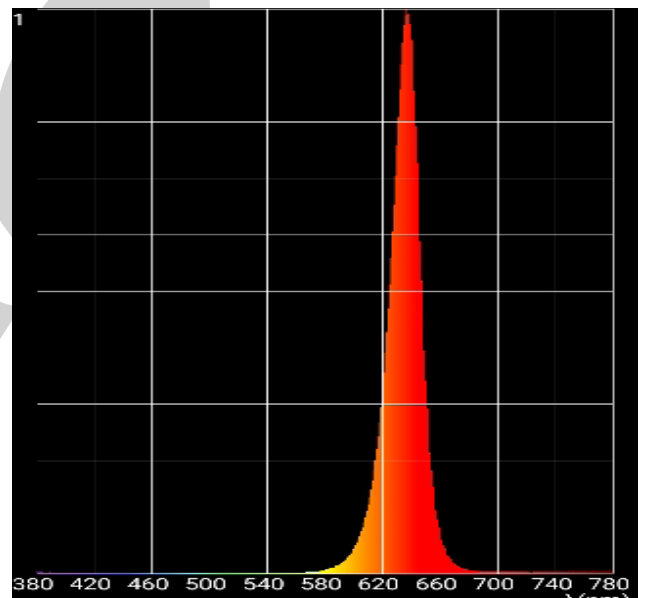
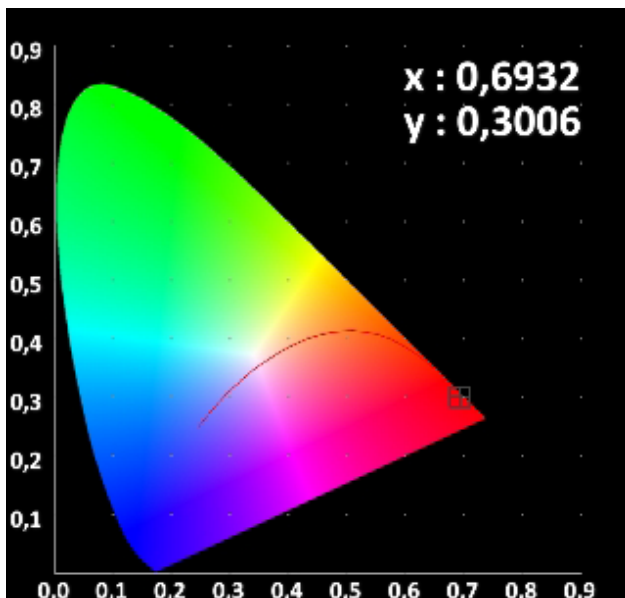

LED VERTE

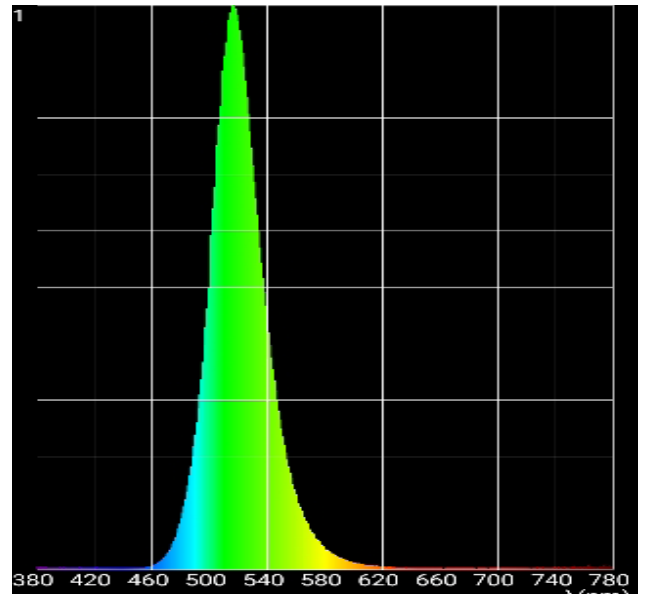
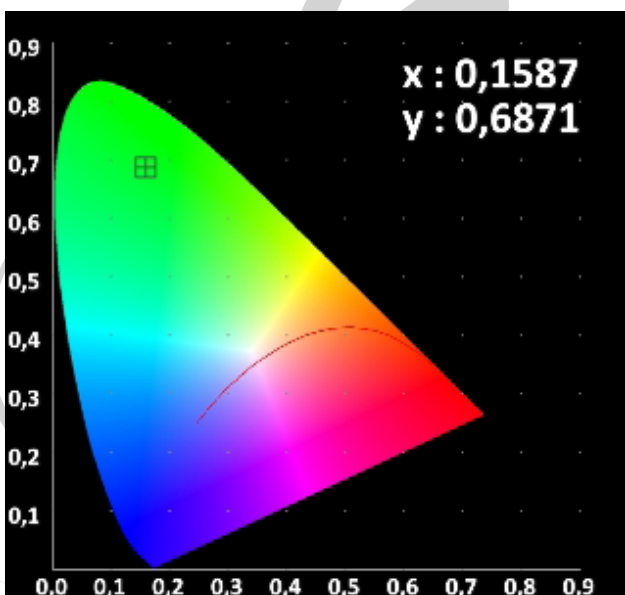

LED BLEU

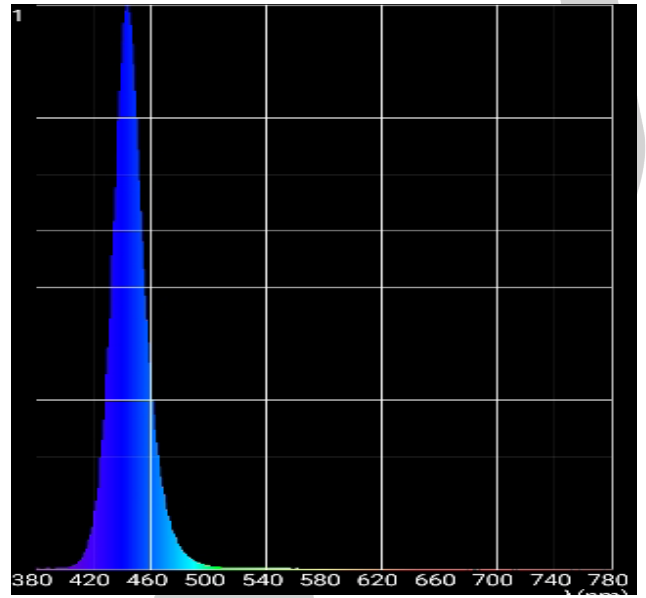
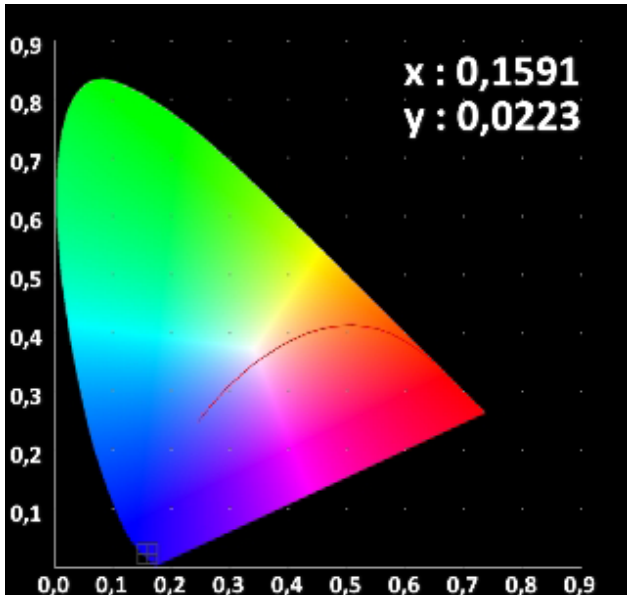

LED BLANCHES

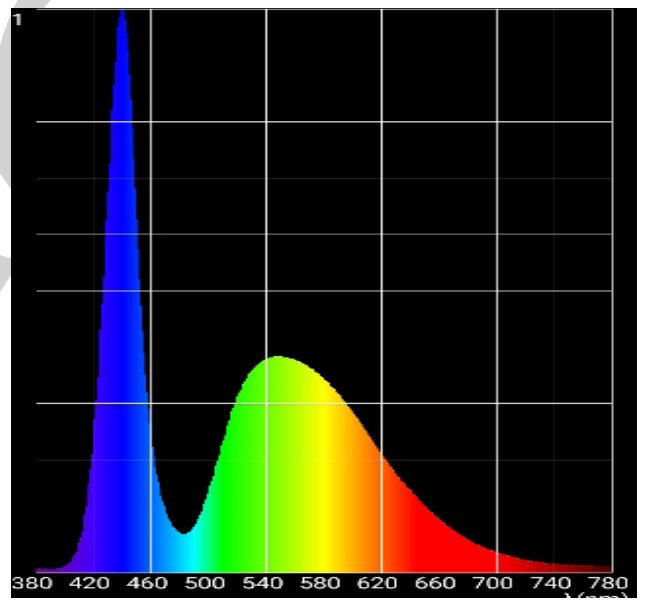
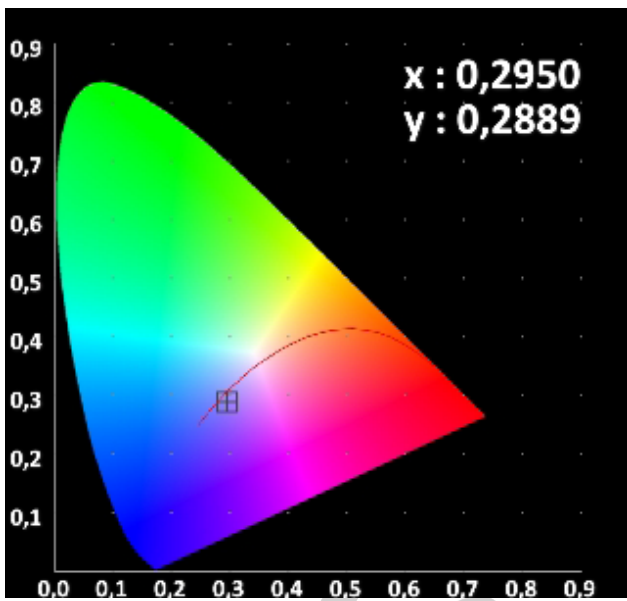

Angle d'ouverture mini

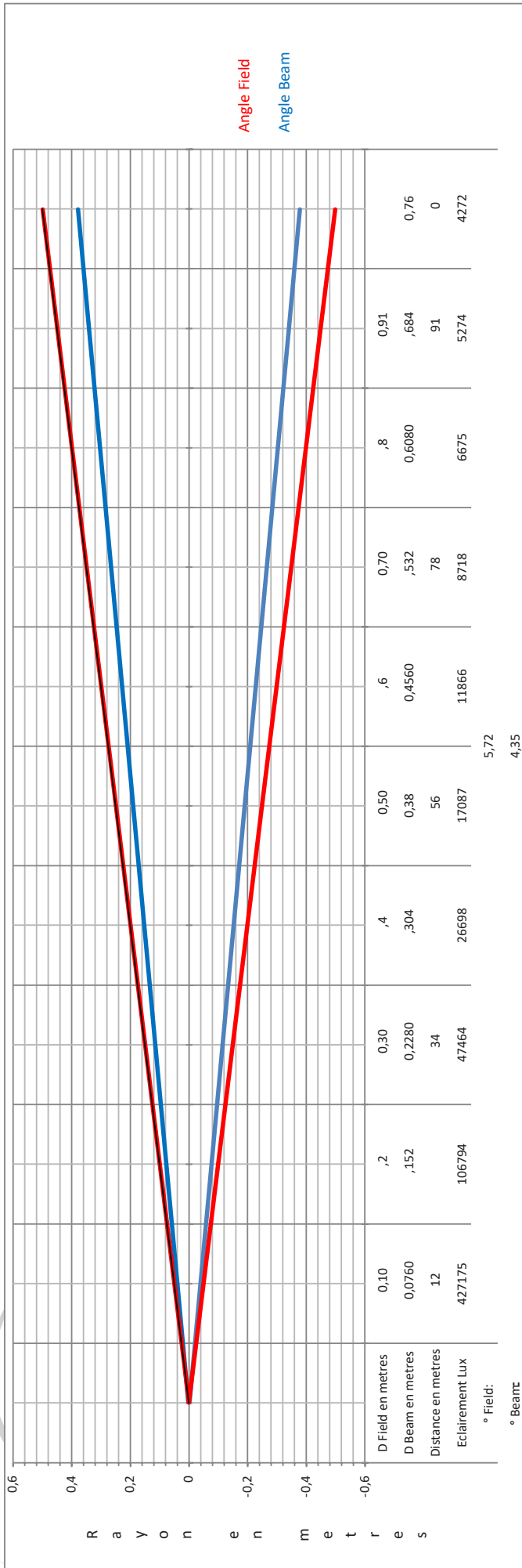

Angle d'ouverture maxi

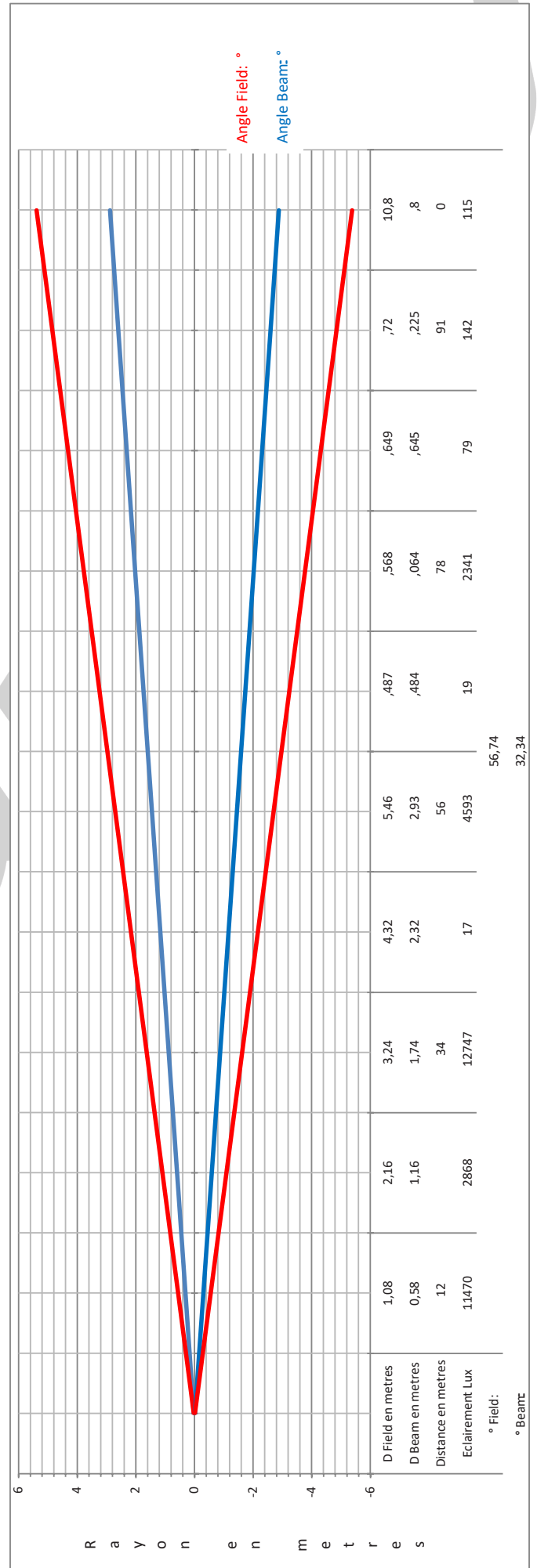

RACCORDEMENT DMX:

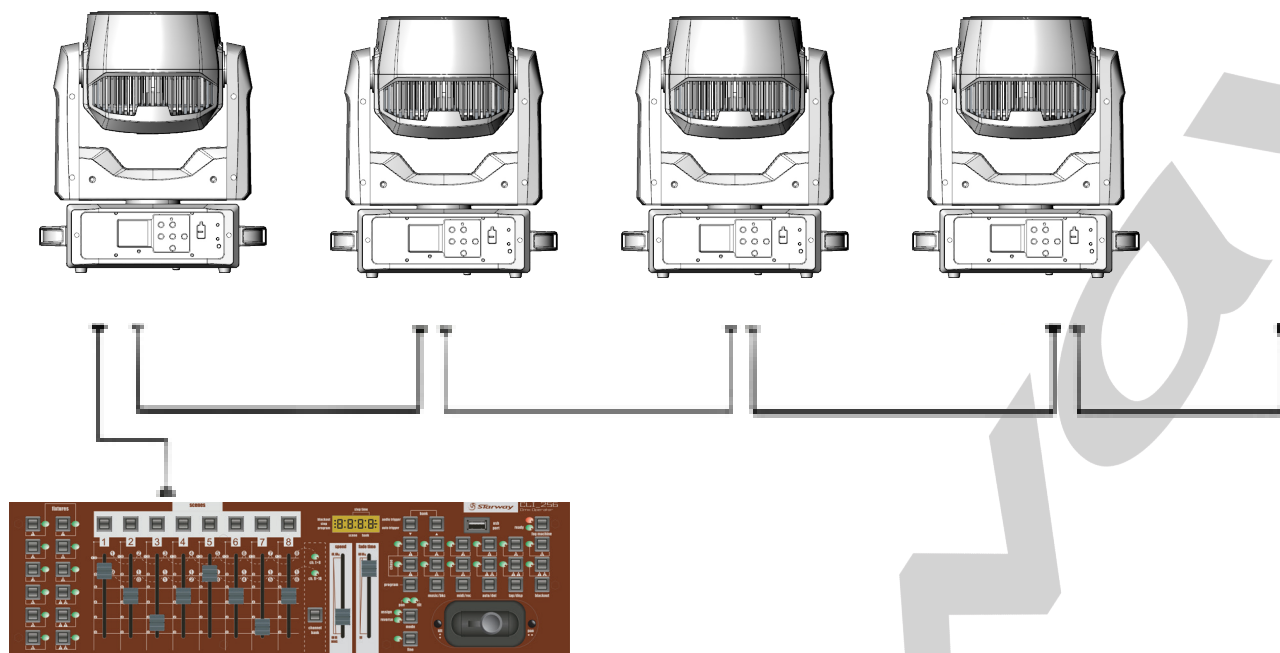

Les projecteurs sont connectés en série à une console DMX.

Raccorder les projecteurs comme le montre le schéma ci-dessus.

- Raccorder le côté mâle du câble DMX à la sortie de la console DMX512.
- Puis connecter la sortie DMX du projecteur à l'entrée du projecteur suivant.
- Répéter l'opération sur l'ensemble de la chaîne.

L'utilisation d'un bouchon de terminaison est vivement conseillée. Dans certains cas l'absence de cette terminaison n'est pas problématique, Par contre sa présence est très vivement conseillée dans des espaces perturbés (Scène, grandes longueur de ligne, studio TV etc.). Sa valeur est généralement de 120 Ohms Le bouchon est une prise XLR mâle dans laquelle est soudé entre 2 et 3 une résistance de 120 Ohms ¼ de W. Ce bouchon évite la réflexion des informations transmises lors de l'utilisation de grandes longueurs de câbles.

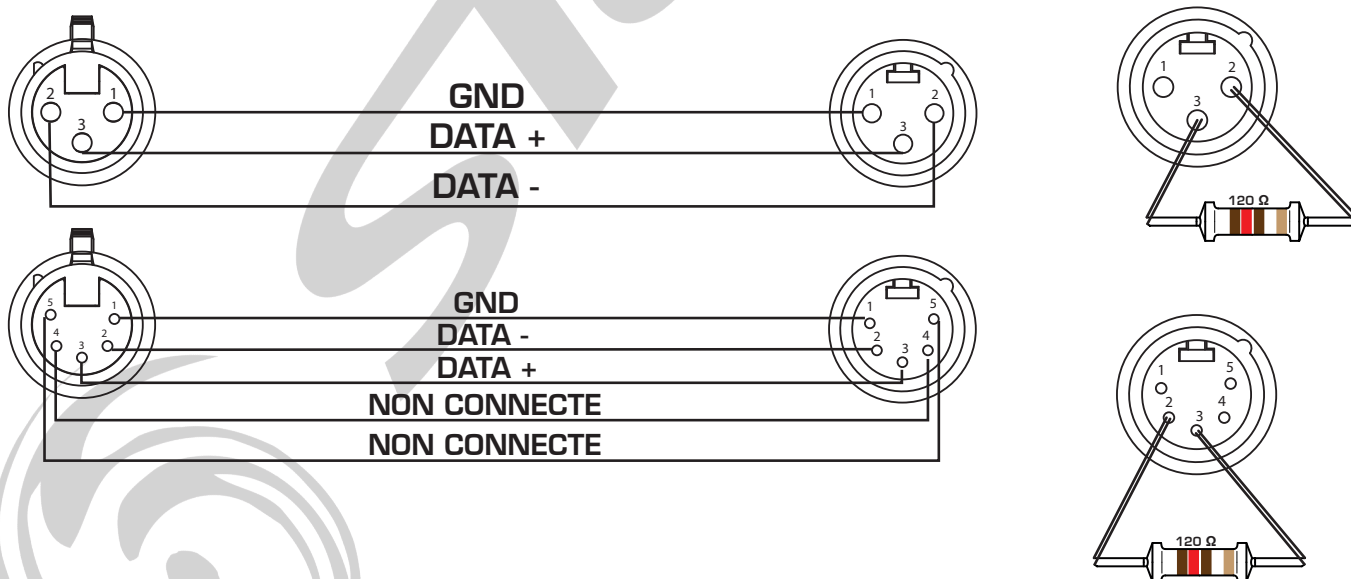

Architecture des menus

LES VALEURS EN **ROUGES** SONT DÉFINIES PAR DÉFAUT DANS LE MENU ET RECHARGÉES TELLES QUE EN CAS DE «RECHARGEMENT DES PARAMÈTRES PAR DÉFAUT»

Receive	Adress mode	1 address	Mode 1 adresse
		2 address	Mode 2 adresses
	Set Address	Address Fixture	A001~Axxx
		Address Leds	A001~Axxx
User Mode	User Mode	Basic 8B	
		Basic 16B	
		Standard 8B	
		Standard 16B	
		Pixel 8B	
		Pixel 16B	
		User A	
		User B	
		User C	
	Edit A		
	Edit B	Max Chan	
	Edit C	PAN, TILT, .../...	
	Function	Status	No DMX Mode
P.Reverse			ON/ OFF
T.Reverse			ON/ OFF
Pan Degree			630/ 540
Feedback			ON /OFF
Move.Spd			Speed 1 ~ 4
Hibernation			OFF , 01M~99M, 15M
Fixture ID		ServicePIN	000-255 (050)
		Universe	000-255
		UnitIPAddr	002.000.000.002
		Mask Addr	255.000.000.000
Protocol Set		ArtNet	
		sACN	
KlingNet		Enable /Disable	
Net Switch		On /Off	
Dim Mode		Standard /Stage/TV/Architectural/Theatre	
Temp. C/F		Celsius	
		Fahrenheit	
Dim Curve		LINEAR	
		Square	
		Inverse Square	
		S-CURVE	

Function (Suite)	Frequency	900HZ/1000HZ/1100HZ/1200HZ/1300HZ/1400HZ/1500HZ/2500HZ/4000HZ/5000HZ/10KHZ/15KHZ/20KHZ/25KHZ			
	Fan Set	Head Fan	Auto		
			High		
			Silent		
	LCD.Set	Backlight	02~60m <05m>		
		FlipDisplay	ON/OFF		
		Key Lock	ON/OFF		
		DispFlash	ON/OFF		
	Disp.Set	Chan.Value	PAN, TILT,		
		Slave Set	Slave1, Slave2, Slave3		
Auto.Prog		Master / Alone			
DFSE	ON/OFF				
USB Update	ON/OFF				
Information	Time.Info	CurrentTime	(Hours)		
		Total Time	(Hours)		
		Last Time	(Hours)		
		Timer PIN	Clear last Password=050, Clear total Password=060		
			Clear Last	ON/OFF	
	Clear Total				
	Temp. Info	XXXF			
	Fan Speed	Fan : xxxxRPM			
	Error. Info	NONE/Pan,Tilt.....			
	Model. Info	MODENA			
Software.Ver-sion	1U01 Vx.x.x 2U01 Vx.x.x 3U01 Vx.x.x 4U01 Vx.x.x 5U01 Vx.x.x 6U01 Vx.x.x				
Test	Reset.Motor	All			
		Pan&Tilt			
		Head			
	Test.Channel	PAN, TILT,			
	Panel.Ctrl.	PAN =XXX			
		TILT=XXX			
		.../...			
	Calibrate	Password - 050			
		PAN			
		TILT			
.../...					

MENU RECEIVE

Address Mode :

Pour faciliter la conception de matrices de leds avec des systèmes de gestion DMX d'entrée de gamme, il est possible d'adresser le Modena de manière classique (tous les canaux sont adressés de manière contiguë), ou de sélectionner une première adresse pour les paramètres généraux du projecteur et une seconde pour la matrice de LEDs.

Set Address :

Configuration de l'adresse DMX du Modena

MENU USER MODE

User Mode :

Sélection du mode DMX du Modena entre les différents modes tels que :

- Basic 8B - 15 canaux DMX - Leds Mode 8 Bits
- Basic 16B - 19 canaux DMX - Leds Mode 16 Bits
- Standard 8B - 21 Canaux DMX - Leds Mode 8 Bits
- Standard 16B - 25 Canaux DMX - Leds Mode 16 Bits
- Pixel 8B - 41 Canaux DMX - Leds pixel/pixels 8 Bits
- Pixel 16B - 9 Canaux DMX - Leds pixel/pixels 16 Bits
- User A - Mode utilisateur 1
- User B - Mode utilisateur 2
- User C - Mode utilisateur 3

Edit A ; Edit B ; Edit C

Dans ce sous menu il est possible de créer 3 affectations de canaux à discrétion de l'utilisateur. Dans chaque sous-menu «Edit A ; Edit B et Edit C» il est possible de sélectionner le nombre de canaux maximum, et de changer l'ordre des canaux DMX.

MENU FUNCTION

Status

Dans ce sous-menu il est possible de modifier le comportement du Modena.

No DMX Mode : Modification de la réaction du Modena lors de la perte de signal DMX :

- Hold : maintien des dernières valeurs DMX reçues
- Auto : Le Modena passe en mode Auto
- Black : Le Modena passe en mode «Stand By»

P Reverse : ON/OFF - Inversion du Pan

T Reverse : ON/OFF - Inversion du Tilt

PAN degree : 630° Ou 540° - Sélection du maximum d'angle de PAN

Feedback : ON/OFF - Activation ou Désactivation du retour d'information des moteurs (Recopie)

Move Speed : Sélection de la vitesse des mouvements entre 1 et 4
1 - plus rapide à 4 - moins rapide

Hibernation

En cas d'absence de signal, le projecteur passera en mode veille jusqu'au retour du signal :

OFF - 01 Min à 99 Min - Sélection du mode d'hibernation du Modena.

OFF par défaut ou de 1 minute à 99 minutes avant le passage en mode hibernation.

Fixture ID

Sous-menu permettant la modification de l'Univers DMX de réception (ArtNet et sACN) ainsi que l'adresse IP et le masque de sous-réseau du Modena.

Universe : 0-255 - Sélection de l'univers DMX de réception

UnitIPAddr : xxx.xxx.xxx.xxx - Sélection de l'adresse IP du Modena

MaskAddr : xxx.xxx.xxx.xxx - Sélection du masque de sous-réseau du Modena

Protocol Set

Sous-menu permettant la sélection du protocole réseau du Modena :
Artnet (par défaut) ou sACN

KlingNet

Sous-menu permettant l'activation ou non du protocole KlingNet :
Enable (par défaut) ou Disable

Net Switch

Sous-menu permettant l'activation ou la désactivation du switch Ethernet du Modena.

Dim Speed

Sous-menu permettant le choix de lissage du dimmer entre Standard (par défaut) , Stage, TV, Architectural ou Theatre.

Temp C°/F°

Sous-menu permettant de sélection du système Celsius (par défaut) ou Fahrenheit, pour l'affichage de la température.

Dim Curve

Sous-menu permettant la sélection de la courbe du dimmer entre Linear (par défaut), Square, Exp, Log et S-Curve

Frequen

Sous-menu permettant la sélection de la fréquence de rafraîchissement de la LED pour éviter un éventuel «flicking» à la captation. Valeur modifiables entre 900Hz (par défaut) et 25Khz.

Fan Set - Head Fan

Sous-menu permettant de sélectionner la vitesse du ventilateur de la tête entre Auto (par défaut) et Low ou High.

LCD Set

Sous-menu permettant de sélectionner le comportement de l'afficheur du Modena.

Backlight - 02m à 60m - Sélection du temps de maintien du rétro éclairage de l'afficheur (sans manipulation du menu) de 2 minutes à 60 minutes. Temps réglé sur 5 minutes par défaut.

Flip Display - ON/OFF - Inversion du sens de l'afficheur

KeyLock - ON/OFF - Verrouillage des boutons du Modena.

DispFlash - ON/OFF - Validation ou non du flash de l'afficheur lorsque le Modena ne reçoit pas de signal DMX.

Disp.Set

Chan.Value - affichage en continu des valeurs DMX de tous les canaux.

Slave Set - Sélection du mode esclave du Modena pour «décaler» les Modena lors de l'utilisation du mode Maître/Esclave - entre Slave 1, Slave2 et Slave 3.

Auto Prog - Sélection du mode Maître/Esclave :

En mode MASTER Le Modena transmet les informations aux Modena connectés à l'aide d'un câble DMX et où le mode Esclave a été activé dans le sous-menu «Slave Set»

En mode ALONE le Modena ne transmet pas les information et exécute son mode AUTO de manière individuelle.

DFSE - ON/OFF - Rechargement des paramètres par défaut du Modena.

USB Update - ON/OFF - Mise à jour du firmware du Modena

PROCÉDURE MISE A JOUR DES FIRMWARE PAR CLÉ USB :

1. Placer les fichiers de mise à jour dans un répertoire sur la clef USB par exemple pour le Modena :

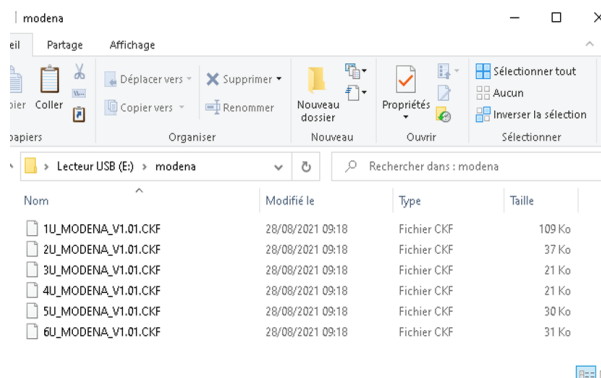

2. Allumer le projecteur et aller dans le menu en pressant « Mode » > « Fonction » > « USB Update » > « On », sortir du menu et éteindre la machine.
3. Machine éteinte, DMX et ARTnet débranchés, insérer la clef dans le connecteur en face avant.
4. Allumer le projecteur > l'écran affiche les répertoires disponibles > sélectionner « Modena »

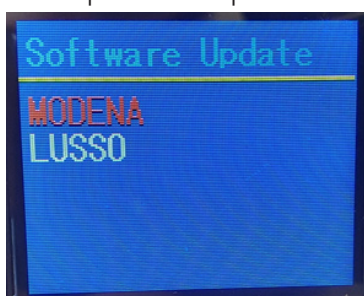

5. Sélectionner « Start » et appuyer sur « Enter »

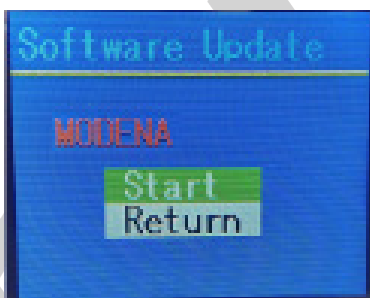

6. Le processus de mise à jour démarre et programmera chaque carte électronique. Le projecteur effectuera un reset à la fin du processus

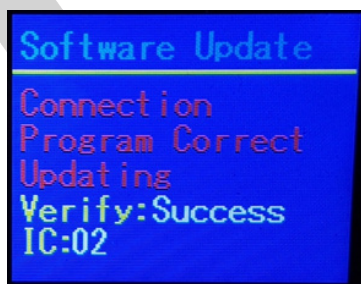

7. Retirer la clé et vérifier les versions de software en pressant «Mode» > «Information» > «Software. V» > «Enter»

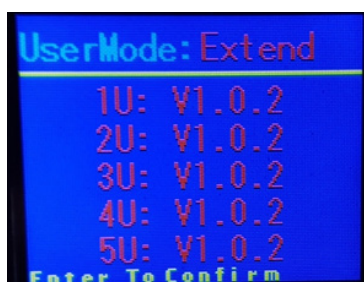

8. Aller dans le menu en pressant «Mode» > «Fonction» > «USB Update» > «OFF», sortir du menu.

MENU INFORMATION

Time.Info

CurrentTime : Affichage du temps d'utilisation (en heures) depuis la dernière mise sous tension

TotalTime : Affichage du temps d'utilisation (en heure) depuis la première mise sous tension.

LastTime : Affichage du temps d'utilisation (en heure) depuis la dernière remise à zéro.

Time PIN : Pour accéder à la remise à zéro des temps d'utilisation il faut entrer un code PIN :

050 pour remettre à zéro le «Last Time»

060 pour remettre à zéro le «TotalTime»

ClearLast : ON/OFF pour remettre à zéro

ClearTOTAL : ON/OFF pour remettre à zéro

Temp.Info - Affichage de la température

xxx F ou C - Affichage de la température d

Fan Speed - Affichage de la vitesse du ventilateur

Fan : xxx RPM

Error.Info - Affichage des 10 derniers messages d'erreur.

Model.Info - Affichage du nom du modèle : MODENA

Software.V - Affichage de la version des différents processeurs

1U01 - Vx.x.x

2U01 - Vx.x.x

3U01 - Vx.x.x

4U01 - Vx.x.x

5U01 - Vx.x.x

6U01 - Vx.x.x

MENU TEST

Reset Motors

ALL : Reset de tous les moteurs

Pan&Tilt : Reset des moteurs Pan et Tilt

Head : Reset du Zoom

Test.Channel

Sous-menu permettant de tester tous les paramètres du Modena tels que :

Pan, Pan Fine, Tilt, Tilt Fine, Red, Red Fine, Green, Green Fine, Blue, Blue Fine, White, White Fine, Strobe, Dimmer, Dim Fine, Zoom, DimMode, P/T Speed, Reset/Prog

Panel.Ctrl.

Sous-menu permettant de contrôler manuellement tous les paramètres du Modena tels que :

Pan, Pan Fine, Tilt, Tilt Fine, Red, Red Fine, Green, Green Fine, Blue, Blue Fine, White, White Fine, Strobe, Dimmer, Dim Fine, Zoom, DimMode, P/T Speed, Reset/Prog

Calibrate :

Sous-menu permettant de recalibrer les moteurs et les Leds du Modena

pour accéder à ce menu il faut entrer le code PIN de déverrouillage de cette fonction.

Code Pin : 050

On accède ainsi aux différents paramètres :

Pan, Pan Fine, Tilt, Tilt Fine, Red, Red Fine, Green, Green Fine, Blue, Blue Fine, White, White Fine, Strobe, Dimmer, Dim Fine, Zoom.

AGENCEMENT DES PIXELS

VUE FACE AFFICHEUR, VALEUR PAN 128 - VALEUR TILT : 17

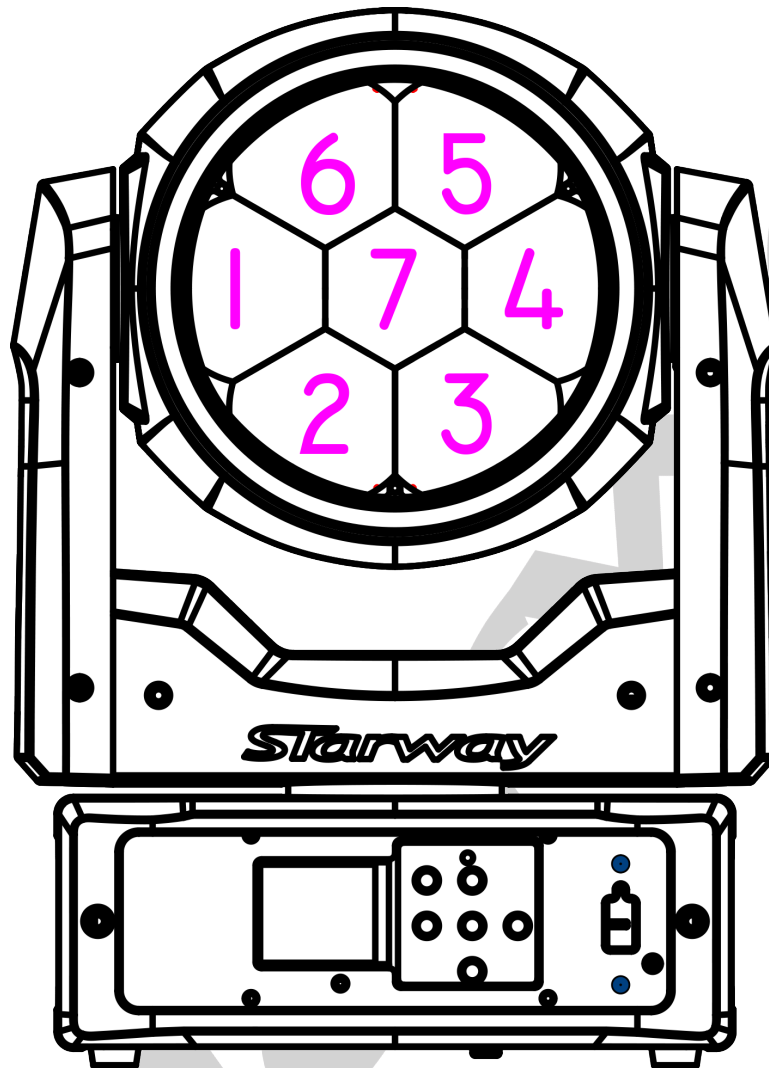

ASSIGNATION DES CANAUX DMX

Mode Basic 8B

1	Pan	000~255	Pan
2	Pan fine	000~255	
3	Tilt	000~255	Tilt
4	Tilt fine	000~255	
5	Vitesse P/T	000~225	De Rapide à Lent
		226~235	Mouvements au Black Out
		236~255	Idle
6	Dimmer	000~255	Dimmer
7	Dimmer Fine	000~255	Dimmer Fine
8	Strobe	000~009	Shutter fermé
		010~019	Shutter ouvert
		020~068	Strobe de lent à rapide
		069~79	Shutter ouvert
		80~128	Pulse en séquences
		129~139	Shutter ouvert
		140~188	Strobe random de lent à rapide
		189~199	Shutter open
		200~248	Strobe pixelrandom de lent à rapide
		249~255	Shutter ouvert
9	Zoom	000~255	Zoom
10	Dim Modes	000~020	Selon le menu du projecteur
		021~040	Standard
		041~060	Stage
		061~080	TV
		081~100	Architectural
		101~255	Theatre
11	Contrôle	000~005	Idle
		006~017	Inversion Pan on (Maintient 3s)
		018~029	Inversion Pan off (Maintient 3s)
		030~041	Inversion Tilt on (Maintient 3s)
		042~053	Inversion Tilt off (Maintient 3s)
		054~065	Fan Silent (Maintient 3s) Le ventilateur tourne à vitesse lente constamment
		066~077	Fan Auto (Maintient 3s) La vitesse du ventilateur est gérée automatiquement
		078~089	Fan High (Maintient 3s) Le ventilateur tourne à vitesse haute constamment
		090~101	Courbe Linear (Maintient 3s)
		102~113	Courbe Square (Maintient 3s)
		114~125	Courbe Inv-Square (Maintient 3s)
		126~131	Courbe S (Maintient 3s)
		132~137	Led Freq. 900 Hz (Maintient 3s)

11	Contrôle	138~143	Led Freq. 1000 Hz (Maintient 3s)
		144~149	Led Freq. 1100 Hz (Maintient 3s)
		150~155	Led Freq. 1200 Hz (Maintient 3s)
		156~161	Led Freq. 1300 Hz (Maintient 3s)
		162~167	Led Freq. 1400 Hz (Maintient 3s)
		168~173	Led Freq. 1500 Hz (Maintient 3s)
		174~179	Led Freq. 2500 Hz (Maintient 3s)
		180~185	Led Freq. 4000 Hz (Maintient 3s)
		186~191	Led Freq. 5000 Hz (Maintient 3s)
		192~197	Led Freq. 10000 Hz (Maintient 3s)
		198~203	Led Freq. 15000 Hz (Maintient 3s)
		204~209	Led Freq. 20000 Hz (Maintient 3s)
		210~215	Led Freq. 25000 Hz (Maintient 3s)
		216~218	Reset Pan/Tilt (Maintient 3s)
		219~221	Reset du zoom (Maintient 3s)
		222~224	Reset général (Maintient 3s)
		225~234	Idle
		235~237	Klingnet Désactivé Les leds sont contrôlées uniquement par le dmx filaire ou Artnet
238~240	Leds controled Klingnet only Les leds sont contrôlées uniquement par le Klingnet		
241~243	Leds controled Klingnet + Dmx Les leds sont contrôlées par le Klingnet mais le dmx est prioritaire sur RGBW		
244~246	Klingnet Calibration OFF De manière à ce que le blanc Klingnet soit raccord avec par exemple un ecran Led, il est possible de le calibrer dans le menu calibration du Modena. Cette calibration peut etre activée ou non depuis la console.		
247~249	Klingnet Calibration ON De manière à ce que le blanc Klingnet soit raccord avec par exemple un ecran Led, il est possible de le calibrer dans le menu calibration du Modena. Cette calibration peut etre activée ou non depuis la console.		
250~252	White Calibred by IC (Maintient 3s) La calibration des macros de blancs est contrôlée par un IC spécialisé.		
253~255	Fixed White values (Maintient 3s) La valeur des macros de blancs est figée dans le software.		
12	Rouge	000~255	Rouge
13	Vert	000~255	Vert
14	Bleu	000~255	Bleu
15	Blanc	000~255	Blanc

Mode Basic 16B

1	Pan	000~255	Pan
2	Pan fine	000~255	
3	Tilt	000~255	Tilt
4	Tilt fine	000~255	
5	Vitesse P/T	000~225	De rapide à lent
		226~235	Mouvements au Blackout
		236~255	Idle
6	Dimmer	000~255	Dimmer
7	Dimmer Fine	000~255	Dimmer fine
8	Strobe	000~009	Shutter fermé
		010~019	Shutter ouvert
		020~068	Strobe de lent à rapide
		069~79	Shutter ouvert
		80~128	Pulse en séquences
		129~139	Shutter ouvert
		140~188	Strobe random de lent à rapide
		189~199	Shutter ouvert
		200~248	Strobe pixels random de lent à rapide
		249~255	Shutter ouvert
9	Zoom	000~255	Zoom
10	Dim Modes	000~020	Selon le menu du projecteur
		021~040	Standard
		041~060	Stage
		061~080	TV
		081~100	Architectural
		101~255	Theatre
11	Contrôle	000~005	Idle
		006~017	Inversion Pan on (Maintient 3s)
		018~029	Inversion Pan off (Maintient 3s)
		030~041	Inversion Tilt on (Maintient 3s)
		042~053	Inversion Tilt off (Maintient 3s)
		054~065	Fan Silent (Maintient 3s) Le ventilateur tourne à vitesse lente constamment
		066~077	Fan Auto (Maintient 3s) La vitesse du ventilateur est gérée automatiquement
		078~089	Fan High (Maintient 3s) Le ventilateur tourne à vitesse rapide constamment
		090~101	Courbe Linear (Maintient 3s)
		102~113	Courbe Square (Maintient 3s)
		114~125	Courbe Inv-Square (Maintient 3s)
		126~131	Courbe S (Maintient 3s)
		132~137	Led Freq. 900 Hz (Maintient 3s)
		138~143	Led Freq. 1000 Hz (Maintient 3s)
144~149	Led Freq. 1100 Hz (Maintient 3s)		

11	Contrôle	150~155	Led Freq. 1200 Hz (Maintient 3s)
		156~161	Led Freq. 1300 Hz (Maintient 3s)
		162~167	Led Freq. 1400 Hz (Maintient 3s)
		168~173	Led Freq. 1500 Hz (Maintient 3s)
		174~179	Led Freq. 2500 Hz (Maintient 3s)
		180~185	Led Freq. 4000 Hz (Maintient 3s)
		186~191	Led Freq. 5000 Hz (Maintient 3s)
		192~197	Led Freq. 10000 Hz (Maintient 3s)
		198~203	Led Freq. 15000 Hz (Maintient 3s)
		204~209	Led Freq. 20000 Hz (Maintient 3s)
		210~215	Led Freq. 25000 Hz (Maintient 3s)
		216~218	Reset Pan/Tilt (Maintient 3s)
		219~221	Reset only Head (Maintient 3s)
		222~224	Reset All Functions (Maintient 3s)
		225~234	Idle
235~237	Klingnet Disable Les leds sont controlées uniquement par le dmx filaire ou Artnet		
238~240	Leds controled Klingnet only Les leds sont controlées uniquement par le Klingnet		
241~243	Leds controled Klingnet + Dmx Les leds sont controlées par le Klingnet mais le dmx est prioritaire sur RGBW		
244~246	Klingnet Calibration OFF De manière à ce que le blanc Klingnet soit raccord avec par exemple un ecran Led, il est possible de le calibrer dans le menu calibration du Modena. Cette calibration peut etre activée ou non depuis la console.		
247~249	Klingnet Calibration ON De manière à ce que le blanc Klingnet soit raccord avec par exemple un ecran Led, il est possible de le calibrer dans le menu calibration du Modena. Cette calibration peut etre activée ou non depuis la console.		
250~252	White Calibred by IC (Maintient 3s) La calibration des macros de blancs est contrôlée par un IC spécialisé.		
253~255	Fixed White values (Maintient 3s) La valeur des macros de blancs est figée dans le software.		
12	Rouge	000~255	Rouge
13	Rouge Fine	000~255	Rouge fine
14	Vert	000~255	Vert
15	Vert Fine	000~255	Vert fine
16	Bleu	000~255	Bleu
17	Bleu Fine	000~255	Bleu fine
18	Blanc	000~255	Blanc
19	Blanc Fine	000~255	Blanc fine

Mode Standard 8B

1	Pan	000~255	Pan	
2	Pan fine	000~255		
3	Tilt	000~255	Tilt	
4	Tilt fine	000~255		
5	Vitesse P/T	000~225	De rapide à lent	
		226~235	Mouvements au Blackout	
		236~255	Idle	
6	Dimmer	000~255	Dimmer	
7	Dimmer Fine	000~255	Dimmer fine	
8	Strobe	000~009	Shutter fermé	
		010~019	Shutter ouvert	
		020~068	Strobe de lent à rapide	
		069~079	Shutter ouvert	
		080~128	Pulse en séquences	
		129~139	Shutter ouvert	
		140~188	Strobe random de lent à rapide	
		189~199	Shutter ouvert	
		200~248	Strobe pixel random de lent à rapide	
		249~255	Shutter ouvert	
9	Roue de Couleur Virtuelle Premier Plan	000-010	Macro de Blanc Les canaux RGBW doivent avoir une valeur de 255 pour obtenir la bonne température de couleur. Est-il possible d'ajuster la couleur avec RGBW	Voir table de la Roue de couleur virtuelle Premier Plan Page 36
		011-250	Roue de couleur virtuelle Seul le canal Blanc est actif et peut modifier la saturation des couleurs	
		251-253	Rotation de la roue couleur virtuelle sens horaire	
		254-255	Rotation de la roue couleur virtuelle sens anti-horaire	
10	Roue de Couleur Virtuelle Arrière Plan	000-010	Macro de Blanc Les canaux RGBW doivent avoir une valeur de 255 pour obtenir la bonne température de couleur. Est-il possible d'ajuster la couleur avec RGBW	Voir table de la Roue de couleur virtuelle Arrière Plan Page 37
		011-251	Roue de couleur virtuelle Seul le canal Blanc est actif et peut modifier la saturation des couleurs	
		252-253	Rotation de la roue couleur virtuelle sens horaire	
		254-255	Rotation de la roue couleur virtuelle sens anti-horaire	
11	Fade / Vitesse roue couleurs	000-255	Fade entre les couleurs virtuelles Rotation de rapide à lent	

12	Patterns	000-009	Pas de Programme	
		010-019	Programme 1	
		020-029	Programme 2	
		030-039	Programme 3	
		040-049	Programme 4	
		050-059	Programme 5	
		060-069	Programme 6	
		070-079	Programme 7	
		080-089	Programme 8	
		090-099	Programme 9	
		100-109	Programme 10	
		110-119	Programme 11	
		120-129	Programme 12	
		130-139	Programme 13	
		140-149	Programme 14	
		150-159	Programme 15	
		160-169	Programme 16	
		170-179	Programme 17	
		180-189	Programme 18	
		190-199	Programme 19	
200-209	Programme 20			
210-219	Klingnet Seulement			
220-255	Klingnet + RGBW actifs			
13	Pas manuels des patterns	000 - 004	Static step 1	
		005 - 009	Static step 2	
		010 - 014	Static step 3	
		015 - 019	Static step 4	
		020 - 024	Static step 5	
		025 - 029	Static step 6	
		030 - 034	Static step 7	
		035 - 039	Static step 8	
	Pas automatiques des patterns	040 - 145	Chase sens horaire (rapide à lent)	
		146 - 149	Stop	
150 - 255		Chase sens anti-horaire (rapide à lent)		
14	Fade des patterns	000	Normal	
		001-255	De rapide à lent	
15	Zoom	000~255	Zoom	
16	Dim Modes	000~020	Selon le menu du projecteur	
		021~040	Standard	
		041~060	Stage	
		061~080	TV	
		081~100	Architectural	
		101~255	Theatre	

17	Contrôle	000~005	Idle
		006~017	Inversion Pan on (Maintient 3s)
		018~029	Inversion Pan off (Maintient 3s)
		030~041	Inversion Tilt on (Maintient 3s)
		042~053	Inversion Tilt off (Maintient 3s)
		054~065	Fan Silent (Maintient 3s) Le ventilateur tourne à vitesse lente constamment
		066~077	Fan Auto (Maintient 3s) La vitesse du ventilateur est gérée automatiquement
		078~089	Fan High (Maintient 3s) Le ventilateur tourne à vitesse rapide constamment
		090~101	Courbe Linear (Maintient 3s)
		102~113	Courbe Square Dimmer Curve (Maintient 3s)
		114~125	Courbe Inv-Square Dimmer Curve (Maintient 3s)
		126~131	Courbe S (Maintient 3s)
		132~137	Led Freq. 900 Hz (Maintient 3s)
		138~143	Led Freq. 1000 Hz (Maintient 3s)
		144~149	Led Freq. 1100 Hz (Maintient 3s)
		150~155	Led Freq. 1200 Hz (Maintient 3s)
		156~161	Led Freq. 1300 Hz (Maintient 3s)
		162~167	Led Freq. 1400 Hz (Maintient 3s)
		168~173	Led Freq. 1500 Hz (Maintient 3s)
		174~179	Led Freq. 2500 Hz (Maintient 3s)
180~185	Led Freq. 4000 Hz (Maintient 3s)		
186~191	Led Freq. 5000 Hz (Maintient 3s)		

17	Control	192~197	Led Freq. 10000 Hz (Maintient 3s)
		198~203	Led Freq. 15000 Hz (Maintient 3s)
		204~209	Led Freq. 20000 Hz (Maintient 3s)
		210~215	Led Freq. 25000 Hz (Maintient 3s)
		216~218	Reset Pan/Tilt (Maintient 3s)
		219~221	Reset only Head (Maintient 3s)
		222~224	Reset All Functions (Maintient 3s)
		225~234	Idle
		235~237	Klingnet Disable Les leds sont controlées uniquement par le dmx filaire ou Artnet
		238~240	Leds controled Klingnet only Les leds sont controlées uniquement par le Klingnet
241~243	Leds controled Klingnet + Dmx Les leds sont controlées par le Klingnet mais le dmx est prioritaire sur RGBW		
244~246	Klingnet Calibration OFF De manière à ce que le blanc Klingnet soit raccord avec par exemple un ecran Led, il est possible de le calibrer dans le menu calibration du Modena. Cette calibration peut etre activée ou non depuis la console.		
247~249	Klingnet Calibration ON De manière à ce que le blanc Klingnet soit raccord avec par exemple un ecran Led, il est possible de le calibrer dans le menu calibration du Modena. Cette calibration peut etre activée ou non depuis la console.		
250~252	White Calibred by IC (Maintient 3s) La calibration des macros de blancs est controllée par un IC spécialisé		
253~255	Fixed White values (Maintient 3s) La valeur des macros de blancs est figée dans le software.		
18	Rouge	000~255	Rouge
19	Vert	000~255	Vert
20	Bleu	000~255	Bleu
21	Blanc	000~255	Blanc

Mode Standard 16B

1	Pan	000~255	Pan	
2	Pan fine	000~255		
3	Tilt	000~255	Tilt	
4	Tilt fine	000~255		
5	Vitesse P/T	000~225	De rapide à lent	
		226~235	Mouvements au Blackout	
		236~255	Idle	
6	Dimmer	000~255	Dimmer	
7	Dimmer Fine	000~255	Dimmer fine	
8	Strobe	000~009	Shutter fermé	
		010~019	Shutter ouvert	
		020~068	Strobe de lent à rapide	
		069~079	Shutter ouvert	
		080~128	Pulse en séquences	
		129~139	Shutter ouvert	
		140~188	Strobe random de lent à rapide	
		189~199	Shutter ouvert	
		200~248	Strobe pixel random de lent à rapide	
		249~255	Shutter ouvert	
9	Roue de Couleur Virtuelle Premier Plan	000-010	Macro de Blanc Les canaux RGBW doivent avoir une valeur de 255 pour obtenir la bonne température de couleur. Est-il possible d'ajuster la couleur avec RGBW	Voir table de la Roue de couleur virtuelle Page 36
		011-250	Roue de couleur virtuelle Seul le canal Blanc est actif et peut modifier la saturation des couleurs	
		251-253	Rotation de la roue couleur virtuelle sens horaire	
		254-255	Rotation de la roue couleur virtuelle sens anti-horaire	
10	Roue de Couleur Virtuelle Arrière Plan	000-010	Macro de Blanc Les canaux RGBW doivent avoir une valeur de 255 pour obtenir la bonne température de couleur. Est-il possible d'ajuster la couleur avec RGBW	Voir table de la Roue de couleur virtuelle Page 37
		011-251	Roue de couleur virtuelle Seul le canal Blanc est actif et peut modifier la saturation des couleurs	
		252-253	Rotation de la roue couleur virtuelle sens horaire	
		254-255	Rotation de la roue couleur virtuelle sens anti-horaire	
11	Fade / Vitesse roue couleurs	000-255	Fade entre les couleurs virtuelles Rotation de rapide à lent	

12	Patterns	000-009	Pas de Programme	
		010-019	Programme 1	
		020-029	Programme 2	
		030-039	Programme 3	
		040-049	Programme 4	
		050-059	Programme 5	
		060-069	Programme 6	
		070-079	Programme 7	
		080-089	Programme 8	
		090-099	Programme 9	
		100-109	Programme 10	
		110-119	Programme 11	
		120-129	Programme 12	
		130-139	Programme 13	
		140-149	Programme 14	
		150-159	Programme 15	
		160-169	Programme 16	
		170-179	Programme 17	
		180-189	Programme 18	
		190-199	Programme 19	
200-209	Programme 20			
210-219	Klingnet Seulement			
220-255	Klingnet + RGBW actifs			
13	Pas manuels des patterns	000 - 004	Static step 1	Sélectionnez l'un des 8 pas du programme sélectionné par le canal 12.
		005 - 009	Static step 2	
		010 - 014	Static step 3	
		015 - 019	Static step 4	
		020 - 024	Static step 5	
		025 - 029	Static step 6	
		030 - 034	Static step 7	
		035 - 039	Static step 8	
	Pas automatiques des patterns	040 - 145	Chase sens horaire (rapide à lent)	Vitesse de défilement
		146 - 149	Stop	
150 - 255		Chase sens anti-horaire (rapide à lent)		
14	Fade des patterns	000	Normal	
		001-255	De rapide à lent	
15	Zoom	000~255	Zoom	
16	Dim Modes	000~020	Selon le menu du projecteur	
		021~040	Standard	
		041~060	Stage	
		061~080	TV	
		081~100	Architectural	
		101~255	Theatre	

17	Contrôle	000~005	Idle
		006~017	Inversion Pan on (Maintient 3s)
		018~029	Inversion Pan off (Maintient 3s)
		030~041	Inversion Tilt on (Maintient 3s)
		042~053	Inversion Tilt off (Maintient 3s)
		054~065	Fan Silent (Maintient 3s) Le ventilateur tourne à vitesse lente constamment
		066~077	Fan Auto (Maintient 3s) La vitesse du ventilateur est gérée automatiquement
		078~089	Fan High (Maintient 3s) Le ventilateur tourne à vitesse rapide constamment
		090~101	Courbe Linear (Maintient 3s)
		102~113	Courbe Square Dimmer Curve (Maintient 3s)
		114~125	Courbe Inv-Square Dimmer Curve (Maintient 3s)
		126~131	Courbe S (Maintient 3s)
		132~137	Led Freq. 900 Hz (Maintient 3s)
		138~143	Led Freq. 1000 Hz (Maintient 3s)
		144~149	Led Freq. 1100 Hz (Maintient 3s)
		150~155	Led Freq. 1200 Hz (Maintient 3s)
		156~161	Led Freq. 1300 Hz (Maintient 3s)
		162~167	Led Freq. 1400 Hz (Maintient 3s)
		168~173	Led Freq. 1500 Hz (Maintient 3s)
		174~179	Led Freq. 2500 Hz (Maintient 3s)
180~185	Led Freq. 4000 Hz (Maintient 3s)		
186~191	Led Freq. 5000 Hz (Maintient 3s)		

17	Control	192~197	Led Freq. 10000 Hz (Maintient 3s)
		198~203	Led Freq. 15000 Hz (Maintient 3s)
		204~209	Led Freq. 20000 Hz (Maintient 3s)
		210~215	Led Freq. 25000 Hz (Maintient 3s)
		216~218	Reset Pan/Tilt (Maintient 3s)
		219~221	Reset only Head (Maintient 3s)
		222~224	Reset All Functions (Maintient 3s)
		225~234	Idle
		235~237	Klingnet Disable Les leds sont controlées uniquement par le dmx filaire ou Artnet
		238~240	Leds controled Klingnet only Les leds sont controlées uniquement par le Klingnet
241~243	Leds controled Klingnet + Dmx Les leds sont controlées par le Klingnet mais le dmx est prioritaire sur RGBW		
244~246	Klingnet Calibration OFF De manière à ce que le blanc Klingnet soit raccord avec par exemple un ecran Led, il est possible de le calibrer dans le menu calibration du Modena. Cette calibration peut etre activée ou non depuis la console.		
247~249	Klingnet Calibration ON De manière à ce que le blanc Klingnet soit raccord avec par exemple un ecran Led, il est possible de le calibrer dans le menu calibration du Modena. Cette calibration peut etre activée ou non depuis la console.		
250~252	White Calibred by IC (Maintient 3s) La calibration des macros de blancs est controllée par un IC spécialisé		
253~255	Fixed White values (Maintient 3s) La valeur des macros de blancs est figée dans le software.		
18	Rouge	000~255	Rouge
19	Rouge Fine	000~255	Rouge Fine
20	Vert	000~255	Vert
21	Vert Fine	000~255	Vert Fine
22	Bleu	000~255	Bleu
23	Bleu Fine	000~255	Bleu Fine
24	Blanc	000~255	Blanc
25	Blanc Fine	000~255	Blanc Fine

Mode Pixel 8B

1	Pan	000~255	Pan	
2	Pan fine	000~255		
3	Tilt	000~255	Tilt	
4	Tilt fine	000~255		
5	Vitesse P/T	000~225	De rapide à lent	
		226~235	Mouvements au Blackout	
		236~255	Idle	
6	Dimmer	000~255	Dimmer	
7	Dimmer Fine	000~255	Dimmer fine	
8	Strobe	000~009	Shutter fermé	
		010~019	Shutter ouvert	
		020~068	Strobe de lent à rapide	
		069~079	Shutter ouvert	
		080~128	Pulse en séquences	
		129~139	Shutter ouvert	
		140~188	Strobe random de lent à rapide	
		189~199	Shutter ouvert	
		200~248	Strobe pixel random de lent à rapide	
		249~255	Shutter ouvert	
9	Roue de Couleur Virtuelle	000-010	Macro de Blanc Les canaux RGBW doivent avoir une valeur de 255 pour obtenir la bonne température de couleur. Est-il possible d'ajuster la couleur avec RGBW	Voir table de la Roue de couleur virtuelle Page 36
		011-250	Roue de couleur virtuelle Seul le canal Blanc est actif et peut modifier la saturation des couleurs	
		251-253	Rotation de la roue couleur virtuelle sens horaire	
		254-255	Rotation de la roue couleur virtuelle sens anti-horaire	
10	Fade / Vitesse roue couleurs	000-255	Fade entre les couleurs virtuelles Rotation de rapide à lent	
11	Zoom	000~255	Zoom	
12	Dim Modes	000~020	Selon le menu du projecteur	
		021~040	Standard	
		041~060	Stage	
		061~080	TV	
		081~100	Architectural	
		101~255	Theatre	

13	Contrôle	000~005	Idle
		006~017	Inversion Pan on (Maintient 3s)
		018~029	Inversion Pan off (Maintient 3s)
		030~041	Inversion Tilt on (Maintient 3s)
		042~053	Inversion Tilt off (Maintient 3s)
		054~065	Fan Silent (Maintient 3s) Le ventilateur tourne à vitesse lente constamment
		066~077	Fan Auto (Maintient 3s) La vitesse du ventilateur est gérée automatiquement
		078~089	Fan High (Maintient 3s) Le ventilateur tourne à vitesse rapide constamment
		090~101	Courbe Linear (Maintient 3s)
		102~113	Courbe Square Dimmer Curve (Maintient 3s)
		114~125	Courbe Inv-Square Dimmer Curve (Maintient 3s)
		126~131	Courbe S (Maintient 3s)
		132~137	Led Freq. 900 Hz (Maintient 3s)
		138~143	Led Freq. 1000 Hz (Maintient 3s)
		144~149	Led Freq. 1100 Hz (Maintient 3s)
		150~155	Led Freq. 1200 Hz (Maintient 3s)
		156~161	Led Freq. 1300 Hz (Maintient 3s)
		162~167	Led Freq. 1400 Hz (Maintient 3s)
		168~173	Led Freq. 1500 Hz (Maintient 3s)
		174~179	Led Freq. 2500 Hz (Maintient 3s)
		180~185	Led Freq. 4000 Hz (Maintient 3s)
		186~191	Led Freq. 5000 Hz (Maintient 3s)
		192~197	Led Freq. 10000 Hz (Maintient 3s)
		198~203	Led Freq. 15000 Hz (Maintient 3s)
		204~209	Led Freq. 20000 Hz (Maintient 3s)
		210~215	Led Freq. 25000 Hz (Maintient 3s)
		216~218	Reset Pan/Tilt (Maintient 3s)
		219~221	Reset only Head (Maintient 3s)
		222~224	Reset All Functions (Maintient 3s)
		225~234	Idle
		235~237	Klingnet Disable Les leds sont controlées uniquement par le dmx filaire ou Artnet
		238~240	Leds controled Klingnet only Les leds sont controlées uniquement par le Klingnet
		241~243	Leds controled Klingnet + Dmx Les leds sont controlées par le Klingnet mais le dmx est prioritaire sur RGBW
244~246	Klingnet Calibration OFF De manière à ce que le blanc Klingnet soit raccord avec par exemple un ecran Led, il est possible de le calibrer dans le menu calibration du Modena. Cette calibration peut etre activée ou non depuis la console.		

13	Contrôle	247~249	Klingnet Calibration ON De manière à ce que le blanc Klingnet soit raccord avec par exemple un écran Led, il est possible de le calibrer dans le menu calibration du Modena. Cette calibration peut être activée ou non depuis la console.
		250~252	White Calibred by IC (Maintient 3s) La calibration des macros de blancs est contrôlée par un IC spécialisé
		253~255	Fixed White values (Maintient 3s) La valeur des macros de blancs est figée dans le software.
14	Rouge 1	000~255	Rouge 1
15	Vert 1	000~255	Vert 1
16	Bleu 1	000~255	Bleu 1
17	Blanc 1	000~255	Blanc 1
18	Rouge 2	000~255	Rouge 2
19	Vert 2	000~255	Vert 2
20	Bleu 2	000~255	Bleu 2
21	Blanc 2	000~255	Blanc 2
22	Rouge 3	000~255	Rouge 3
23	Vert 3	000~255	Vert 3
24	Bleu 3	000~255	Bleu 3
25	Blanc 3	000~255	Blanc 3
26	Rouge 4	000~255	Rouge 4
27	Vert 4	000~255	Vert 4
28	Bleu 4	000~255	Bleu 4
29	Blanc 4	000~255	Blanc 4
30	Rouge 5	000~255	Rouge 5
31	Vert 5	000~255	Vert 5
32	Bleu 5	000~255	Bleu 5
33	Blanc 5	000~255	Blanc 5
34	Rouge 6	000~255	Rouge 6
35	Vert 6	000~255	Vert 6
36	Bleu 6	000~255	Bleu 6
37	Blanc 6	000~255	Blanc 6
38	Rouge 7	000~255	Rouge 7
39	Vert 7	000~255	Vert 7
40	Bleu 7	000~255	Bleu 7
41	Blanc 7	000~255	Blanc 7

Mode Pixel 16B

1	Pan	000~255	Pan	
2	Pan fine	000~255		
3	Tilt	000~255	Tilt	
4	Tilt fine	000~255		
5	Vitesse P/T	000~225	De rapide à lent	
		226~235	Mouvements au Blackout	
		236~255	Idle	
6	Dimmer	000~255	Dimmer	
7	Dimmer Fine	000~255	Dimmer fine	
8	Strobe	000~009	Shutter fermé	
		010~019	Shutter ouvert	
		020~068	Strobe de lent à rapide	
		069~079	Shutter ouvert	
		080~128	Pulse en séquences	
		129~139	Shutter ouvert	
		140~188	Strobe random de lent à rapide	
		189~199	Shutter ouvert	
		200~248	Strobe pixel random de lent à rapide	
		249~255	Shutter ouvert	
9	Roue de Couleur Virtuelle	000-010	Macro de Blanc Les canaux RGBW doivent avoir une valeur de 255 pour obtenir la bonne température de couleur. Est-il possible d'ajuster la couleur avec RGBW	Voir table de la Roue de couleur virtuelle Page 36
		011-250	Roue de couleur virtuelle Seul le canal Blanc est actif et peut modifier la saturation des couleurs	
		251-253	Rotation de la roue couleur virtuelle sens horaire	
		254-255	Rotation de la roue couleur virtuelle sens anti-horaire	
10	Fade / Vitesse roue couleurs	000-255	Fade entre les couleurs virtuelles Rotation de rapide à lent	
11	Zoom	000~255	Zoom	
12	Dim Modes	000~020	Selon le menu du projecteur	
		021~040	Standard	
		041~060	Stage	
		061~080	TV	
		081~100	Architectural	
		101~255	Theatre	

13	Contrôle	000~005	Idle
		006~017	Inversion Pan on (Maintient 3s)
		018~029	Inversion Pan off (Maintient 3s)
		030~041	Inversion Tilt on (Maintient 3s)
		042~053	Inversion Tilt off (Maintient 3s)
		054~065	Fan Silent (Maintient 3s) Le ventilateur tourne à vitesse lente constamment
		066~077	Fan Auto (Maintient 3s) La vitesse du ventilateur est gérée automatiquement
		078~089	Fan High (Maintient 3s) Le ventilateur tourne à vitesse rapide constamment
		090~101	Courbe Linear (Maintient 3s)
		102~113	Courbe Square Dimmer Curve (Maintient 3s)
		114~125	Courbe Inv-Square Dimmer Curve (Maintient 3s)
		126~131	Courbe S (Maintient 3s)
		132~137	Led Freq. 900 Hz (Maintient 3s)
		138~143	Led Freq. 1000 Hz (Maintient 3s)
		144~149	Led Freq. 1100 Hz (Maintient 3s)
		150~155	Led Freq. 1200 Hz (Maintient 3s)
		156~161	Led Freq. 1300 Hz (Maintient 3s)
		162~167	Led Freq. 1400 Hz (Maintient 3s)
		168~173	Led Freq. 1500 Hz (Maintient 3s)
		174~179	Led Freq. 2500 Hz (Maintient 3s)
		180~185	Led Freq. 4000 Hz (Maintient 3s)
		186~191	Led Freq. 5000 Hz (Maintient 3s)
		192~197	Led Freq. 10000 Hz (Maintient 3s)
		198~203	Led Freq. 15000 Hz (Maintient 3s)
		204~209	Led Freq. 20000 Hz (Maintient 3s)
		210~215	Led Freq. 25000 Hz (Maintient 3s)
		216~218	Reset Pan/Tilt (Maintient 3s)
		219~221	Reset only Head (Maintient 3s)
		222~224	Reset All Functions (Maintient 3s)
		225~234	Idle
		235~237	Klingnet Disable Les leds sont controlées uniquement par le dmx filaire ou Artnet
		238~240	Leds controled Klingnet only Les leds sont controlées uniquement par le Klingnet
		241~243	Leds controled Klingnet + Dmx Les leds sont controlées par le Klingnet mais le dmx est prioritaire sur RGBW
244~246	Klingnet Calibration OFF De manière à ce que le blanc Klingnet soit raccord avec par exemple un ecran Led, il est possible de le calibrer dans le menu calibration du Modena. Cette calibration peut etre activée ou non depuis la console.		

13	Contrôle	247~249	Klingnet Calibration ON De manière à ce que le blanc Klingnet soit raccord avec par exemple un écran Led, il est possible de le calibrer dans le menu calibration du Modena. Cette calibration peut être activée ou non depuis la console.
		250~252	White Calibrated by IC (Maintient 3s) La calibration des macros de blancs est contrôlée par un IC spécialisé
		253~255	Fixed White values (Maintient 3s) La valeur des macros de blancs est figée dans le software.
14	Rouge 1	000~255	Rouge 1
15	Rouge 1 Fine	000~255	Rouge 1 Fine
16	Vert 1	000~255	Vert 1
17	Vert 1 Fine	000~255	Vert 1 Fine
18	Bleu 1	000~255	Bleu 1
19	Bleu 1 Fine	000~255	Bleu 1 Fine
20	Blanc 1	000~255	Blanc 1
21	Blanc 1 Fine	000~255	Blanc 1 Fine
22	Rouge 2	000~255	Rouge 2
23	Rouge 2 Fine	000~255	Rouge 2 Fine
24	Vert 2	000~255	Vert 2
25	Vert 2 Fine	000~255	Vert 2 Fine
26	Bleu 2	000~255	Bleu 2
27	Bleu 2 Fine	000~255	Bleu 2 Fine
28	Blanc 2	000~255	Blanc 2
29	Blanc 2 Fine	000~255	Blanc 2 Fine
30	Rouge 3	000~255	Rouge 3
31	Rouge 3 Fine	000~255	Rouge 3 Fine
32	Vert 3	000~255	Vert 3
33	Vert 3 Fine	000~255	Vert 3 Fine
34	Bleu 3	000~255	Bleu 3
35	Bleu 3 Fine	000~255	Bleu 3 Fine
36	Blanc 3	000~255	Blanc 3
37	Blanc 3 Fine	000~255	Blanc 3 Fine
38	Rouge 4	000~255	Rouge 4
39	Rouge 4 Fine	000~255	Rouge 4 Fine
40	Vert 4	000~255	Vert 4
41	Vert 4 Fine	000~255	Vert 4 Fine
42	Bleu 4	000~255	Bleu 4
43	Bleu 4 Fine	000~255	Bleu 4 Fine
44	Blanc 4	000~255	Blanc 4
45	Blanc 4 Fine	000~255	Blanc 4 Fine
46	Rouge 5	000~255	Rouge 5
47	Rouge 5 Fine	000~255	Rouge 5 Fine

48	Vert 5	000~255	Vert 5
49	Vert 5 Fine	000~255	Vert 5 Fine
50	Bleu 5	000~255	Bleu 5
51	Bleu 5 Fine	000~255	Bleu 5 Fine
52	Blanc 5	000~255	Blanc 5
53	Blanc 5 Fine	000~255	Blanc 5 Fine
54	Rouge 6	000~255	Rouge 6
55	Rouge 6 Fine	000~255	Rouge 6 Fine
56	Vert 6	000~255	Vert 6
57	Vert 6 Fine	000~255	Vert 6 Fine
58	Bleu 6	000~255	Bleu 6
59	Bleu 6 Fine	000~255	Bleu 6 Fine
60	Blanc 6	000~255	Blanc 6
61	Blanc 6 Fine	000~255	Blanc 6 Fine
62	Rouge 7	000~255	Rouge 7
63	Rouge 7 Fine	000~255	Rouge 7 Fine
64	Vert 7	000~255	Vert 7
65	Vert 7 Fine	000~255	Vert 7 Fine
66	Bleu 7	000~255	Bleu 7
67	Bleu 7 Fine	000~255	Bleu 7 Fine
68	Blanc 7	000~255	Blanc 7
69	Blanc 7 Fine	000~255	Blanc 7 Fine

TABLE ROUE DE COULEUR VIRTUELLE PREMIER PLAN

DMX	Couleur
0	RGBW max
1	Blanc 10000° K
2	Blanc 8000° K
3	Blanc 6500° K
4	Blanc 5600° K
5	Blanc 5000° K
6	Blanc 4500° K
7	Blanc 4000° K
8	Blanc 3200° K
9	Blanc 3000° K
10	Blanc 2700° K
11	Rouge
↕	
51	Jaune
↕	
91	Vert
↕	
171	Bleu
↕	
211	Magenta
↕	
251	Rouge
252	Rotation de la roue couleurs virtuelle >>
253	
254	Rotation de la roue couleurs virtuelle <<
255	

TABLE ROUE DE COULEUR VIRTUELLE ARRIÈRE PLAN

DMX	Couleur
0	PAS D'ARRIÈRE PLAN
1	Blanc 10000° K
2	Blanc 8000° K
3	Blanc 6500° K
4	Blanc 5600° K
5	Blanc 5000° K
6	Blanc 4500° K
7	Blanc 4000° K
8	Blanc 3200° K
9	Blanc 3000° K
10	Blanc 2700° K
11	Rouge
↕	
51	Jaune
↕	
91	Vert
↕	
171	Bleu
↕	
211	Magenta
↕	
251	Rouge
252	Rotation de la roue couleurs virtuelle >>
253	
254	Rotation de la roue couleurs virtuelle <<
255	

LES CANAUX RVBW N'ONT AUCUNE ACTION SUR CETTE ROUE DE COULEUR VIRTUELLE PUISQU'ILS CONTRÔLENT UNIQUEMENT LE PREMIER PLAN.

***T**able of Contents*

Technical Specifications	39
Introduction	39
Dimensions.....	39
Regulation Safety.....	40
Spectrometry.....	42
DMX connection.....	45
Menu.....	46
Pixel Layout	52
DMX map.....	53



TECHNICAL SPECIFICATIONS :

- Zoom 4.35 ° - 32 ° beam (5 ° - 55 ° Field)
- Illuminance: 17000 Lux at 5M / 4.35 °
- Max flux 3650 Lumens
- Cooling: Forced air 3 modes
- DMX modes: 15/19/21/25/41 / 69ch
- Protocols: DMX / Artnet / sACN / Klingnet / RDM
- 20 internal pattern programs
- BColor System
- Flicker Free: Led frequency adjustable from 900 to 25000Hz
- Dmx In / Out connectors: 2 x XLR5.
- Artnet / sACN / Klingnet -connectors: 2 x RJ45
- Dimensions W x D x H: 292MM * 180MM * 334MM (including handles)
256MM*180MM*334MM (without handles)
- Net weight: 7.38Kg with Omega grip.
- Max power: 300W

Introduction:

This product has been dedicated for indoor use only. Particularly suitable for scenes. TV set or clubs. Controllable in DMX these projectors can be controlled by any DMX console.

DIMENSIONS (mm) :

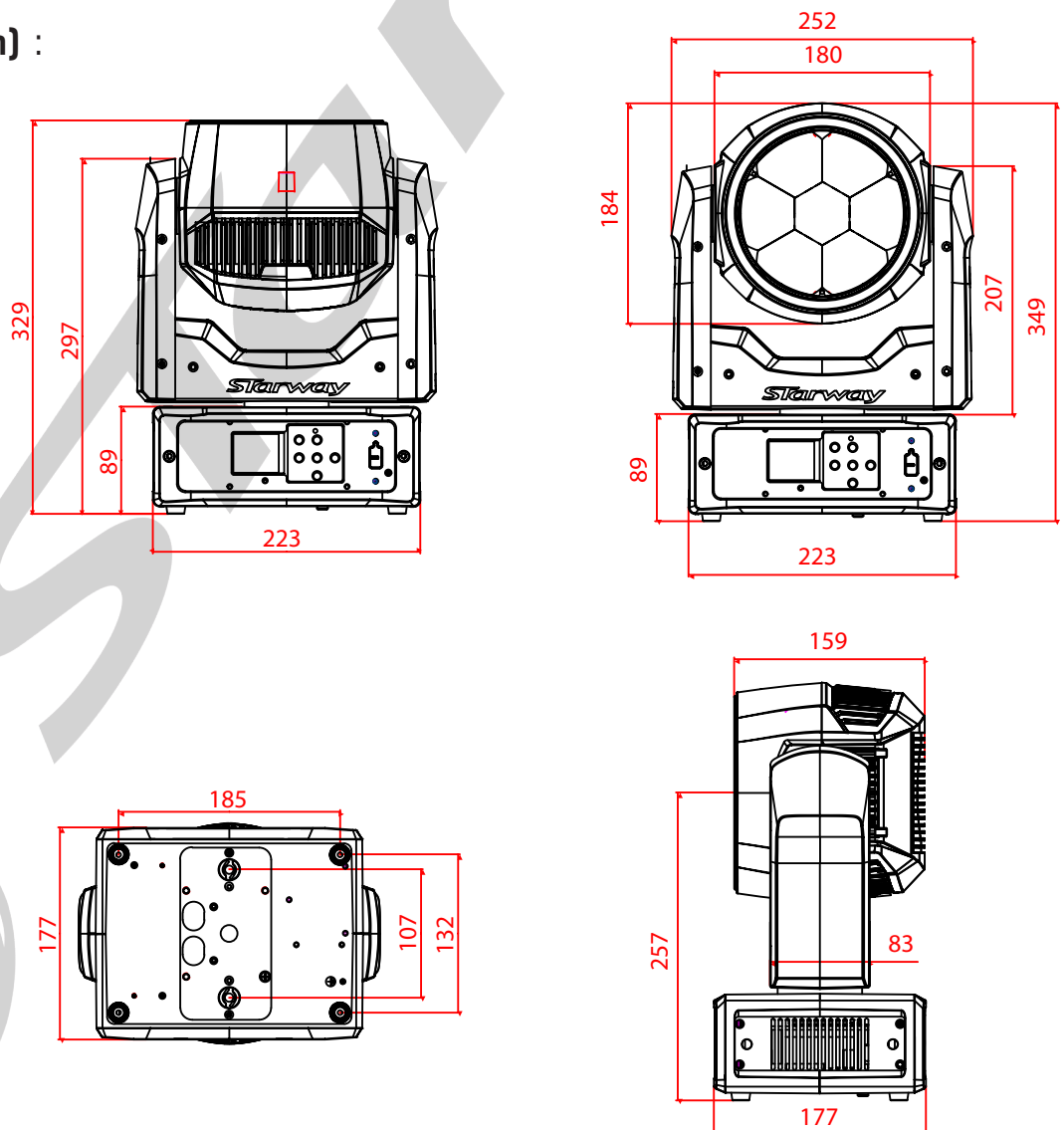



WARNING! Before carrying out any operations with the unit, carefully read this instruction manual and keep it with care for future reference. It contains important information about the installation, usage and maintenance of the unit.



SAFETY

GENERAL INSTRUCTION

- The products referred to in this manual conform to the European Community Directives and are therefore marked with CE:.
- The unit is supplied with hazardous network voltage (230V~). Leave servicing to skilled personnel only. Never make any modifications on the unit not described in this instruction manual, otherwise you will risk an electric shock.
- Connection must be made to a power supply system fitted with efficient earthing (Class I appliance according to standard EN 60598-1). It is, moreover, recommended to protect the supply lines of the units from indirect contact and/or shorting to earth by using appropriately sized residual current devices.
- The connection to the main network of electric distribution must be carried out by a qualified electrical installer. Check that the main frequency and voltage correspond to those for which the unit is designed as given on the electrical data label.
- Never use the fixture under the following conditions:
 - in places wet;
 - in places subject to vibrations or bumps;
 - in places with an ambient temperature of over 45° C.
- Make certain that no inflammable liquids, water or metal objects enter the fixture.
- Do not dismantle or modify the fixture.
- All work must always be carried out by qualified technical personnel. Contact the nearest sales point for an inspection or contact the manufacturer directly.
- If the unit is to be put out of operation definitively, take it to a local recycling plant for a disposal which is not harmful to the environment.

WARNINGS AND INSTALLATION PRECAUTIONS

- Never let the power cord come into contact with other cables! Handle the power cord and all connections with the mains with particular caution!
- Never modify, bend, mechanically strain, put pressure on, pull or heat up the power cord.
- Never strain the cable. There must always be sufficient cable going to the device. Otherwise, the cable will be damaged, which can cause serious damage.
- Never remove warning or informative labels from the unit.
- Never use anything to cover the ground contact.
- Never lift the device holding it by the projector-head, as the mechanics may be damaged
- Do not shake the device. Avoid brute force when installing or operating the device.
- Only operate the device after having checked if the housing is firmly closed and all screws are tightly fastened.
- Only operate the device after having familiarized with its functions.
- Avoid flames and do not put close to flammable liquids or gases.
- Always allow a free air space of at least 0.8 m around the unit for ventilation.
- Always disconnect power from the mains, when device is not used or before cleaning! Only handle the power cord holding it by the plug. Never pull out the plug by tugging the power cord.

- Make sure that the device is not exposed to extreme heat or dust.
- Make sure that the available voltage is not higher than stated on the rear panel.
- Make sure that the power cord is never crimped or damaged. Check the device and the power cord from time to time.
- Make sure that the core diameter of extension cords and power cords is sufficient for the required power consumption of the device.
- Always hold the device by the transport handles.
- Never place any material over the LEDs or lens.
- Never look directly into the light source.
- Never leave any cables lying around.
- Never use the device during thunderstorms, unplug the device immediately.
- Never leave various parts of the packaging (plastic bags, polystyrene foam, nails, etc within children's reach, as they potential sources of danger.
- Do not insert objects into air vents.
- Do not open the device and do not modify the device.
- Do not connect this device to a dimmer pack.
- Do not switch the device on and off in short intervals, as this will reduce the device's life.
- Do not touch the device's housing bare-handed during its operation (housing becomes very hot). Allow the device to cool for at least 5 minutes before handling.
- If the lens or LEDs are obviously damaged, they need to be replaced to prevent their functions from being impaired, due to cracks or deep scratches.
- If the external cable is damaged, it has to be replaced by a qualified technician.
- If device was dropped or struck, disconnect mains power supply immediately. Have a qualified engineer inspect for safety before operating.
- If the device has been exposed to drastic temperature fluctuation (e.g. after transportation), do not switch it on immediately. The arising condensation water might damage your device. Leave the device switched off until it has reached room temperature.
- If your device fails to work properly, discontinue the use immediately. Pack the unit securely (preferably in the original packing material), and return it to your dealer for service.
- For adult use only. The device must be installed beyond the reach of children. Never leave the unit running unattended.
- Never attempt to bypass the thermostatic switch or fuses.
- For replacement use fuses of same type and rating only.
- This device is heavy. When handling, use a two-person lift to prevent injury.
- The user is responsible for correct positioning and operating of the device. The manufacturer will not accept liability for damages caused by the misuse or incorrect installation of this device.
- This device falls under protection class I. Therefore it is essential to connect the yellow/green conductor to earth.
- Repairs, servicing and electric connection must be carried out by a qualified technician.

Rigging

This device is heavy. When handling, use a two-person lift to prevent injury. Please follow the European and national guidelines concerning rigging, trussing and all other safety issues.

SPECTROMETRY

Distance 5 meters		
Color	Wave Length	Lux
Red	637 nm	3006 lux
Green	516 nm	6309 lux
Blue	443 nm	1192 lux
White		8000 lux
RGWB LEDs 4.35°		17090 lux
RGWB LEDs 32°		460 lux

MEASUREMENTS MADE WITH *USPECTRUM MK305S*

RED LED

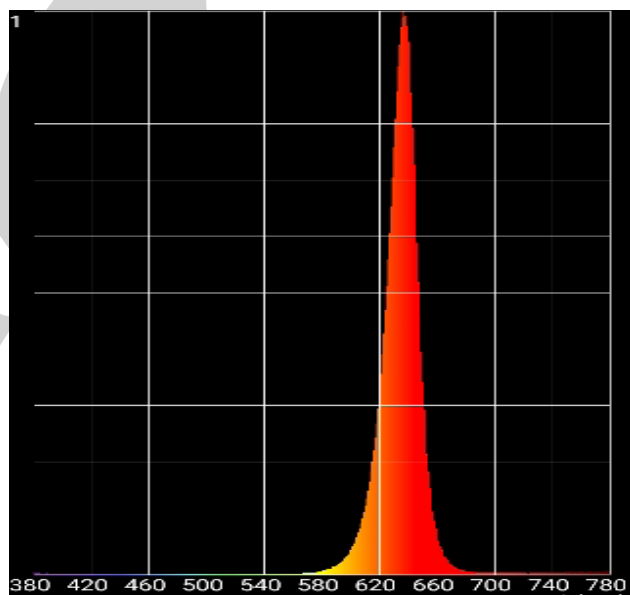
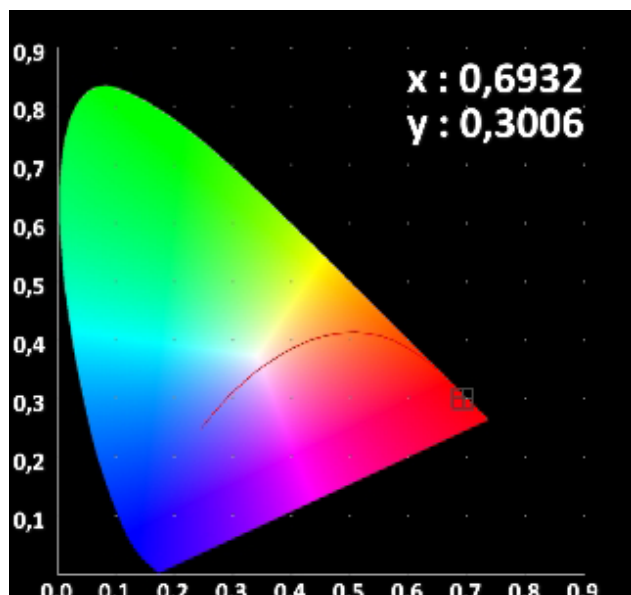

GREEN LED

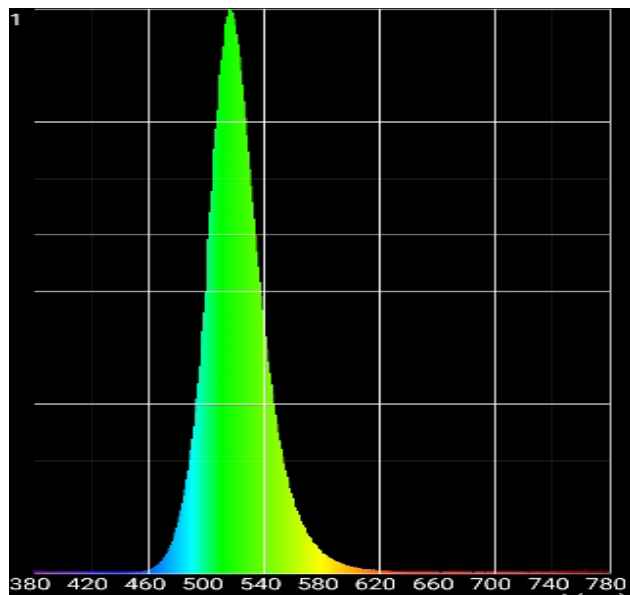
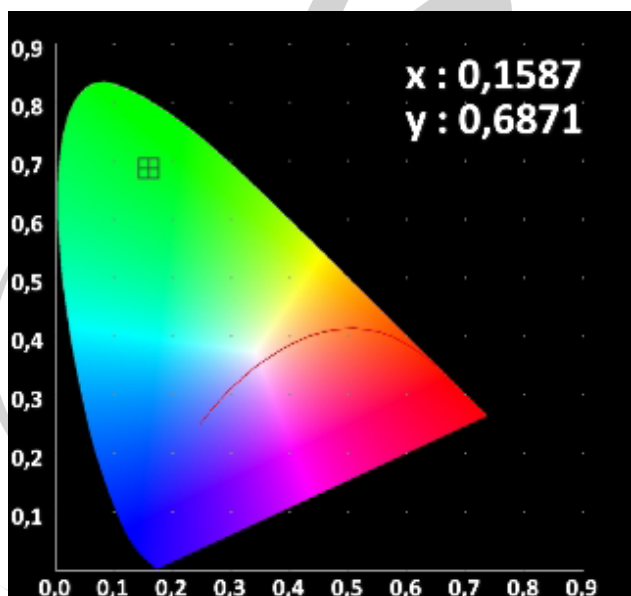

BLUE LED

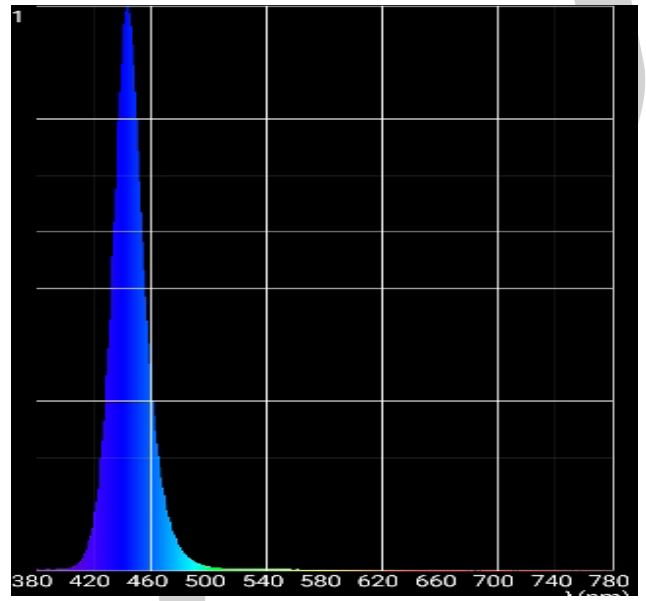
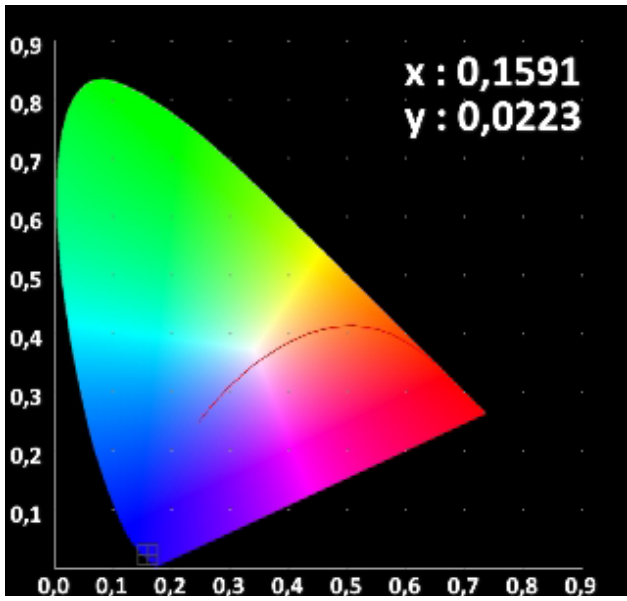

WHITE LED

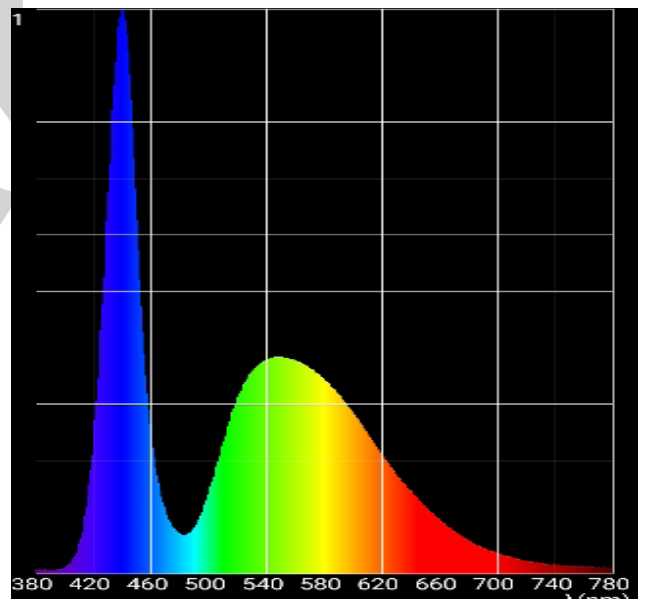
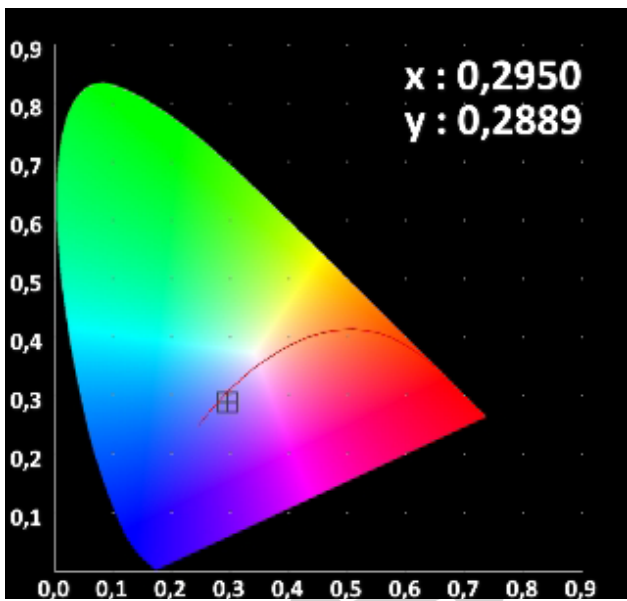

MINIMUM ANGLE

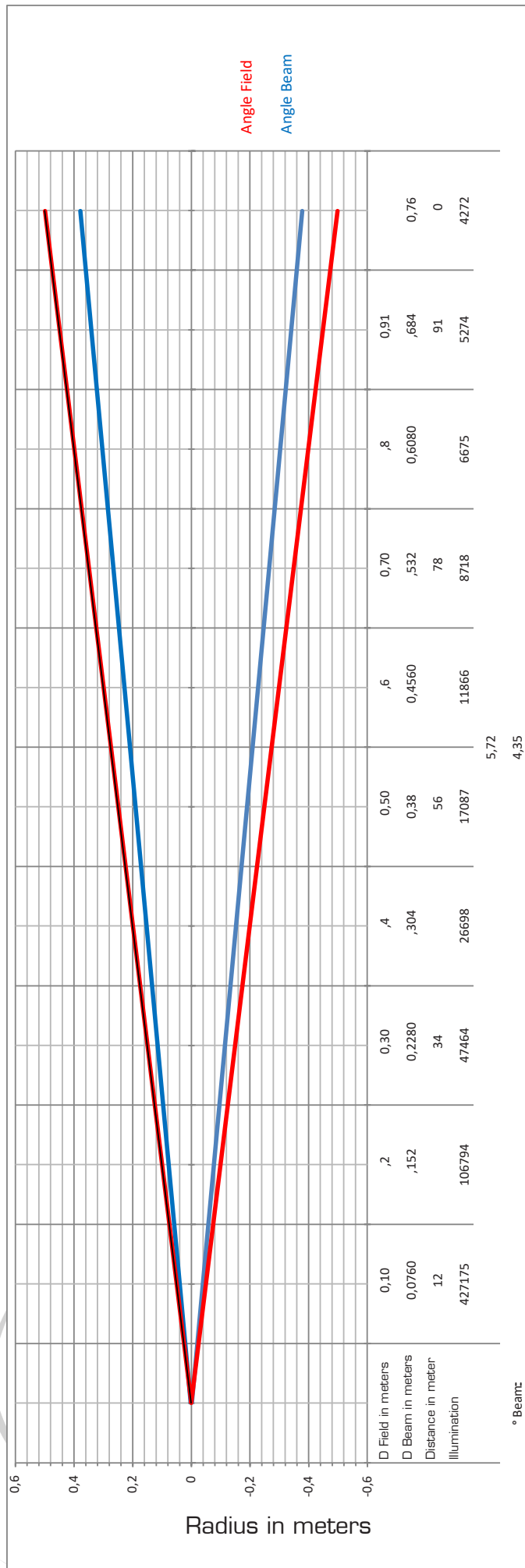

MAXIMUM ANGLE

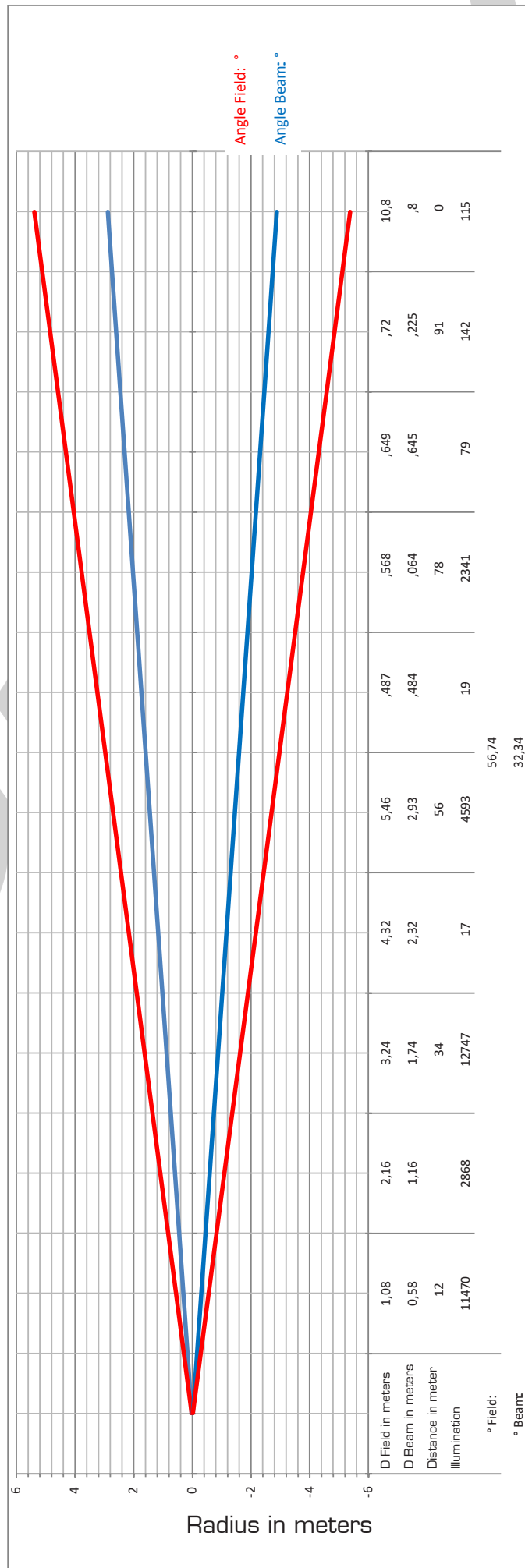

DMX CONNECTION

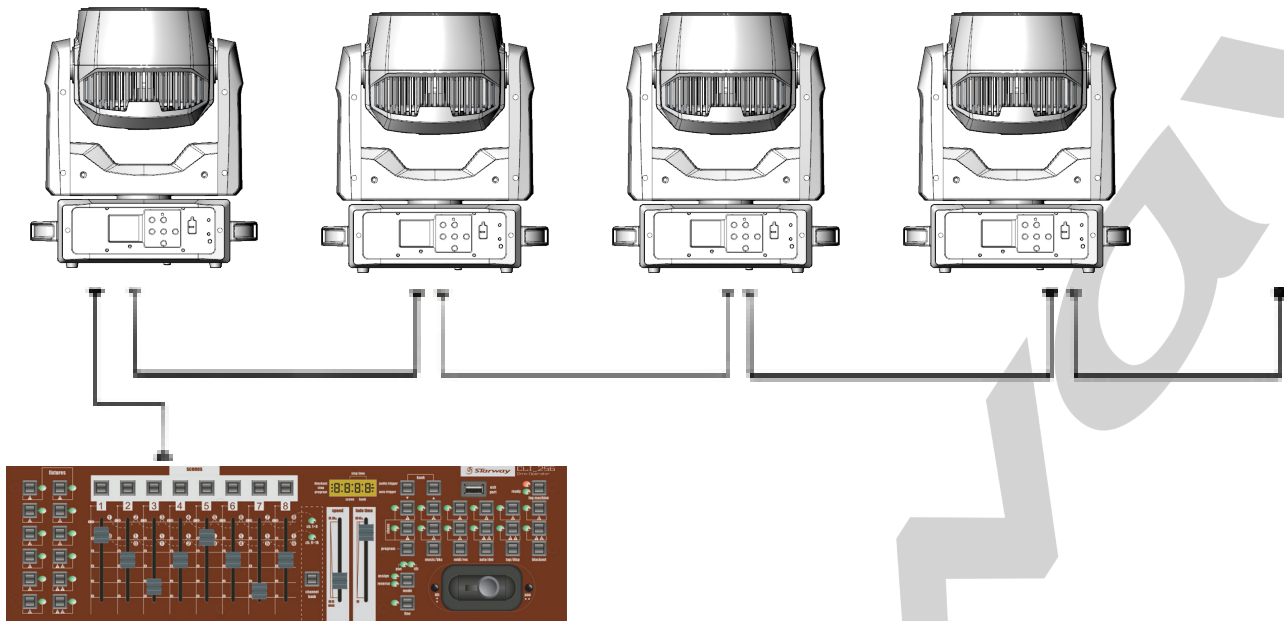

The projectors are connected in series to a DMX console. Connect the projectors as shown in the diagram above.

- Connect the male side of the DMX cable to the output of the DMX512 console.
- Then connect the DMX output of the projector to the input of the next projector.
- Repeat the operation on the whole chain.

The use of a termination plug is strongly recommended. In some cases the absence of this termination is not problematic, on the other hand its presence is very strongly recommended in disturbed spaces (Stage, long line length, TV studio etc.). Its value is generally 120 Ohms. The plug is an XLR male plug into which a resistance of 120 Ohms $\frac{1}{4}$ of W. is welded between 2 and 3. This plug prevents the reflection of information transmitted when using long lengths of cable.

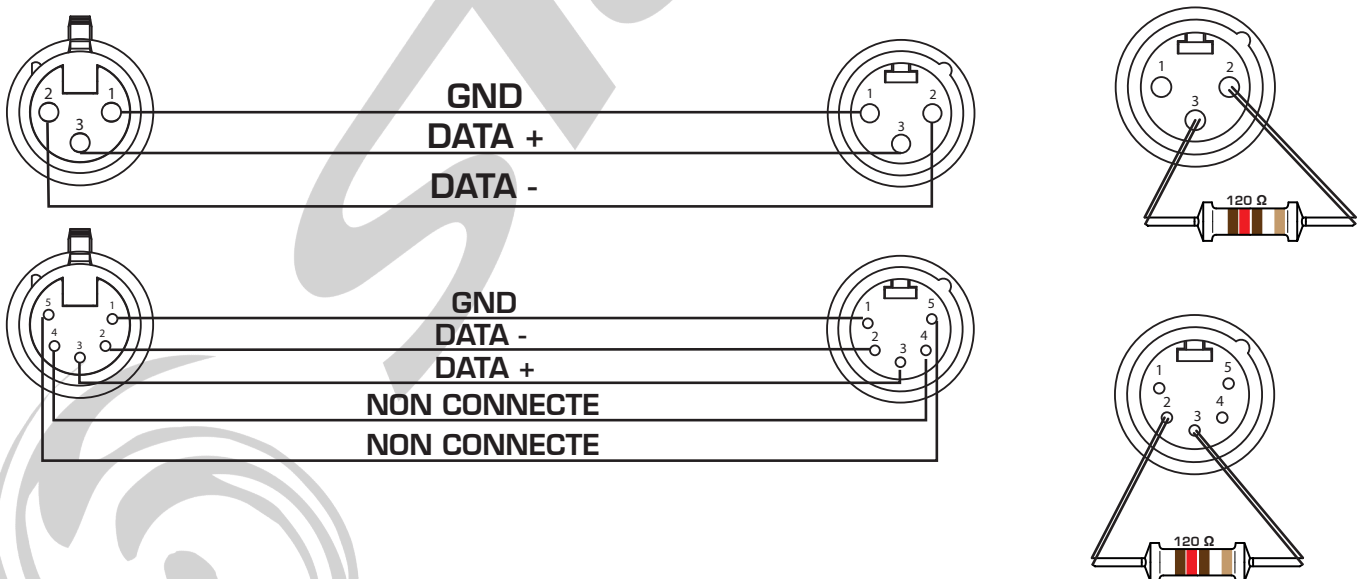

MENU

THE VALUES IN **RED** ARE DEFINED BY DEFAULT IN THE MENU
AND RELOADED AS IN THE CASE OF
«RELOAD DEFAULT SETTINGS»

Receive	Adress mode	1 address	This choice is only 1 address
		2 address	This choice is 2 address
	Set Address	Adress Fixture	A001~A004
		Address Leds	A001~A004
User Mode	User Mode	Basic 8B	
		Basic 16B	
		Standard 8B	
		Standard 16B	
		Pixel 8B	
		Pixel 16B	
		User A	
		User B	
		User C	
	Edit A	Max Chan PAN, TILT, .../...	
	Edit B		
Edit C			
Function	Status	No DMX Mode	Hold /Auto/black
		P.Reverse	ON/ OFF
		T.Reverse	ON/ OFF
		Pan Degree	630/ 540
		Feedback	ON /OFF
		Move.Spd	Speed 1 ~ 4
		Hibernation	OFF , 01M~99M, 15M
	Fixture ID	ServicePIN	000-255 (050)
		Universe	000-255
		UnitIPAddr	002.000.000.002
		Mask Addr	255.000.000.000
	Protocol Set	ArtNet	
		sACN	
	KlingNet	Enable /Disable	
	Net Switch	On /Off	
	Dim Mode	Standard /Stage/TV/Architectural/Theatre	
	Temp. C/F	Celsius	
		Fahrenheit	
	Dim Curve	LINEAR	
		Square	
		Inverse Square	
S-CURVE			

Function	Frequency	900HZ/1000HZ/1100HZ/1200HZ/1300HZ/ 1400HZ/1500HZ/2500HZ/4000HZ/5000HZ/ 10KHZ/15KHZ/20KHZ/25KHZ			
	Fan Set	Head Fan	Auto		
			High		
			Silent		
	LCD.Set	Backlight	02~60m <05m>		
		FlipDisplay	ON/OFF		
		Key Lock	ON/OFF		
		DispFlash	ON/OFF		
	Disp.Set	Chan.Value	PAN, TILT,		
		Slave Set	Slave1, Slave2, Slave3		
Auto.Prog		Master / Alone			
DFSE	ON/OFF				
USB Update	ON/OFF				
Information	Time.Info	CurrentTime	(Hours)		
		Total Time	(Hours)		
		Last Time	(Hours)		
		Timer PIN	Clear last Password=050, Clear total Password=060		
			Clear Last	ON/OFF	
	Clear Total				
	Temp. Info	XXXX			
	Fan Speed	Fan : xxxxRPM			
	Error. Info	NONE/Pan,Tilt.....			
	Model. Info	MODENA			
Software.Ver- sion	1U01 Vx.x.x 2U01 Vx.x.x 3U01 Vx.x.x 4U01 Vx.x.x 5U01 Vx.x.x 6U01 Vx.x.x				
Test	Reset.Motor	All			
		Pan&Tilt			
		Head			
	Test.Channel	PAN, TILT,			
	Panel.Ctrl.	PAN =XXX			
		TILT=XXX			
		.../...			
	Calibrate	Password - 050			
		PAN			
		TILT			
.../...					

RECEIVE

Address Mode :

To facilitate the design of LED arrays with entry-level DMX lighting desk, it is possible to address the Modena in the classic way (all channels are addressed contiguously). Or to select a first address for the general parameters of the projector and a second for the matrix of LEDs.

Set Address :

Configuration of the Modena DMX address

USER MODE

User Mode :

Selection of the DMX mode of the Modena between the different modes such as:

- Basic 8B - 15 channels DMX - Leds Mode 8 Bits
- Basic 16B - 19 channels DMX - Leds Mode 16 Bits
- Standard 8B - 21 channels DMX - Leds Mode 8 Bits
- Standard 16B - 25 channels DMX - Leds Mode 16 Bits
- Pixel 8B - 41 channels DMX - Leds pixel/pixels 8 Bits
- Pixel 16B - 9 channels DMX - Leds pixel/pixels 16 Bits
- User A - User mode 1
- User B - User mode 2
- User C - User mode 3

Edit A ; Edit B ; Edit C

In this sub-menu it is possible to create 3 channel assignments at the discretion of the user. In each "Edit A; Edit B and Edit C "it is possible to select the maximum number of channels, and to change the order of the DMX channels.

FUNCTION

Status

In this sub-menu it is possible to modify the behavior of the Modena.

No DMX Mode : Modification of the Modena reaction during DMX signal loss :

- Hold : Hold the last DMX values received
- Auto : The Modena switches to Auto mode
- Black : The Modena goes into «Stand By» mode

P Reverse : ON/OFF - Pan inversion

T Reverse : ON/OFF - Tilt inversion

PAN degree : 630° or 540° - Selection of the maximum angle of PAN

Feedback : ON/OFF - Activation or Deactivation of motors feedback

Move Speed : Selection of movement speed between 1 and 4
1 - faster to 4 - slower

Hibernation

If there is no signal, the projector will go into standby mode until the signal returns:
OFF - 01 Min to 99 Min - Selection of the Modena hibernation mode.
OFF by default or from 1 minute to 99 minutes before switching to hibernation mode.

Fixture ID

Sub-menu allowing the modification of the receiving DMX universe (ArtNet and sACN) as well as Modena's IP address and the subnet mask.

Universe: 0-255 - Selection of the DMX receiving universe

UnitIPAddr: xxx.xxx.xxx.xxx - Selection of the Modena IP address

MaskAddr: xxx.xxx.xxx.xxx - Selection of the Modena subnet mask

Protocol Set

Sub-menu allowing the selection of the Modena network protocol:
Artnet (by default) or sACN

KlingNet

Submenu allowing KlingNet protocol activation or not:
Enable (default) or Disable

Net Switch

Sub-menu allowing the activation or deactivation of Modena's Ethernet switch

Dim Speed

Sub-menu allowing the dimmer's smoothing choice between Standard (default), Stage, TV, Architectural or Theater.

Temp C°/F°

Sub-menu for selecting the Celsius (default) or Fahrenheit system, for displaying the temperature.

Dim Curve

Submenu allowing the selection of the dimmer curve between Linear (default), Square, Exp, Log and S-Curve.

Frequen

Sub-menu allowing the selection of the refresh rate of the LED to avoid a possible «flicking» during video filming. Changeable value between 900Hz (default) and 25Khz.

Fan Set - Head Fan

Sub-menu for selecting the head fan behavior between Auto (default) and Low or High.

LCD Set

Sub-menu allowing to select the behavior of Modena's display.

Backlight - 02m to 60m - Selection of the display backlight retention time (without menu manipulation) from 2 minutes to 60 minutes. Time set to 5 minutes by default.

Flip Display - ON / OFF - Reversal of the display direction

KeyLock - ON / OFF - Locking of the Modena's buttons.

DispFlash - ON / OFF - Activation or not of the display flash when the Modena does not receive a DMX signal.

Disp.Set

Chan.Value - continuous display of DMX values of all channels.

Slave Set - Selection of Modena slave mode to "offset" Modena when using Master / Slave mode - between Slave 1, Slave2 and Slave 3.

Auto Prog - Master / Slave mode selection:

In MASTER mode, master Modena transmits the information to all Modena connected using a DMX cable and where Slave mode has been activated in the "Slave Set" submenu

In ALONE mode Modena does not transmit information and executes its AUTO mode individually.

DFSE - ON/OFF - Reloading the Modena default settings.

USB Update - ON/OFF - Modena firmware update.

MODENA FIRMWARE UPDATE

1. Place the update files in a directory on the USB key, for example Lusso:

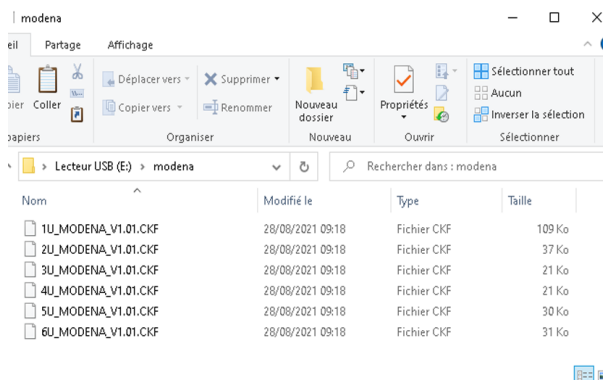

2. Turn on the projector and go to the menu by pressing “Mode” > “Function” > “USB Update” > “On”, exit the menu and turn off the projector.
3. Projector off, DMX and ARTnet disconnected, insert the USB key into the connector located on the front panel.
4. Turn on the projector > the screen displays the available directories> select «MODENA»

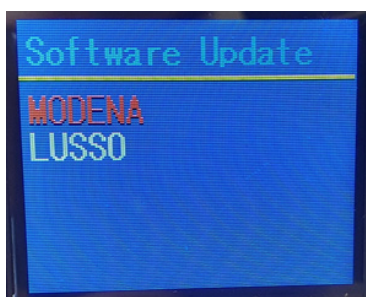

5. Select «Start» and press «Enter»

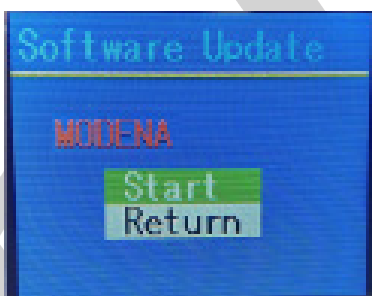

6. The update process starts and will upgrade each electronic board. The projector will perform a reset at the end of the process

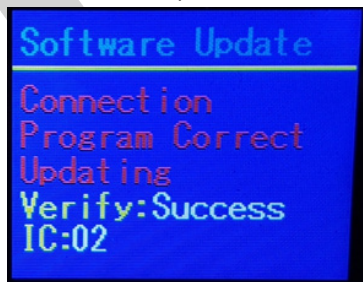

7. Remove the key and check the software versions by pressing «Mode» > «Information» > «Software. V» > «Enter»

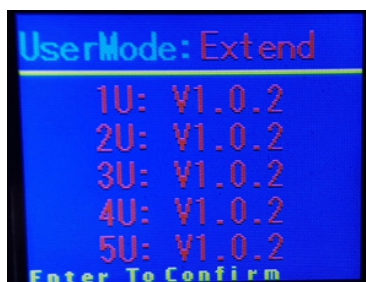

8. Go to the menu by pressing “Mode” > “Function” > “USB Update” > “OFF”, exit the menu.

INFORMATION

Time.Info

CurrentTime: Display of the usage time (in hours) since the last power on
TotalTime: Display of the usage time (in hours) since the first power-up.
LastTime: Display of the usage time (in hours) since the last reset.
Time PIN: To access the reset of usage times you must enter a PIN code:
050 to reset the "Last Time"
060 to reset the "TotalTime"
ClearLast: ON / OFF to reset
ClearTOTAL: ON / OFF to reset

Temp.Info - Temperature display
xxx F or C - Temperature display

Fan Speed - Fan speed display
Fan : xxx RPM

Error.Info - Display of the last 10 error messages.

Model.Info - Display of model name : MODENA

Software.V - Display of the version of the various processors

1U01 - Vx.x.x
2U01 - Vx.x.x
3U01 - Vx.x.x
4U01 - Vx.x.x
5U01 - Vx.x.x
6U01 - Vx.x.x

MENU TEST

Reset Motors

ALL : Reset of all motors
Pan&Tilt : Reset of Pan and Tilt motors
Head : Zoom reset

Test.Channel

Sub-menu allowing you to test all Modena parameters such as:
Pan, Pan Fine, Tilt, Tilt Fine, Red, Red Fine, Green, Green Fine, Blue, Blue Fine, White, White Fine, Strobe, Dimmer, Dim Fine, Zoom, DimMode, P/T Speed, Reset/Prog

Panel.Ctrl.

Submenu allowing manual control of all Modena parameters such as:
Pan, Pan Fine, Tilt, Tilt Fine, Red, Red Fine, Green, Green Fine, Blue, Blue Fine, White, White Fine, Strobe, Dimmer, Dim Fine, Zoom, DimMode, P/T Speed, Reset/Prog

Calibrate :

Sub-menu allowing to recalibrate the motors and the LEDs
To access this menu you must enter the PIN code to unlock this function.
Pin Code: 050

This gives you access to the following parameters:
Pan, Pan Fine, Tilt, Tilt Fine, Red, Red Fine, Green, Green Fine, Blue, Blue Fine, White, White Fine, Strobe, Dimmer, Dim Fine, Zoom.

PIXEL LAYOUT

DISPLAY FRONT VIEW, PAN VALUE : 128 - TILT VALUE : 17

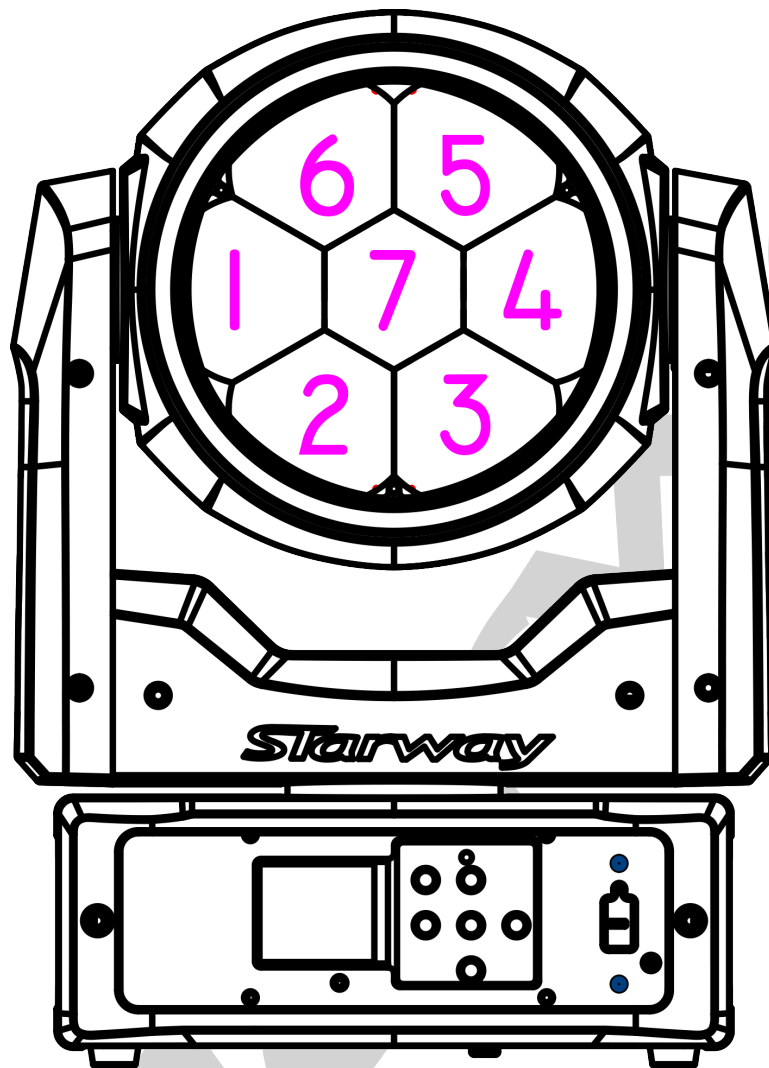

DMX CHART

Basic 8B

1	Pan	000~255	Pan
2	Pan fine	000~255	
3	Tilt	000~255	Tilt
4	Tilt fine	000~255	
5	P/T Speed	000~225	Max to min speed
		226~235	Blackout by movement
		236~255	Idle
6	Dimmer	000~255	General dimmer
7	Dimmer Fine	000~255	General dimmer fine
8	Strobe	000~009	Shutter closed
		010~019	Shutter open
		020~068	Strobe effect slow to fast
		069~79	Shutter open
		80~128	Pulse-effect in sequences
		129~139	Shutter open
		140~188	Random strobe effect slow to fast
		189~199	Shutter open
		200~248	Random flash Pixel slow to fast
		249~255	Shutter open
9	Zoom	000~255	Zoom
10	Dim Modes	000~020	Default unit setting
		021~040	Standard
		041~060	Stage
		061~080	TV
		081~100	Architectural
		101~255	Theatre
11	Control	000~005	Idle
		006~017	Invert Pan on (Hold 3s)
		018~029	Invert Pan off (Hold 3s)
		030~041	Invert Tilt on (Hold 3s)
		042~053	Invert Tilt off (Hold 3s)
		054~065	Fan Silent (Hold 3s) The fan turn always at same low speed
		066~077	Fan Auto (Hold 3s) The fan speed increase with temp
		078~089	Fan High (Hold 3s) The fan turn always at same high speed
		090~101	Linear Dimmer Curve (hold 3s)
		102~113	Square Dimmer Curve (hold 3s)
		114~125	Inv-Square Dimmer Curve (hold 3s)
		126~131	S - Dimmer Curve (hold 3s)
		132~137	Led Freq. 900 Hz (hold 3s)

11	Control	138~143	Led Freq. 1000 Hz (hold 3s)
		144~149	Led Freq. 1100 Hz (hold 3s)
		150~155	Led Freq. 1200 Hz (hold 3s)
		156~161	Led Freq. 1300 Hz (hold 3s)
		162~167	Led Freq. 1400 Hz (hold 3s)
		168~173	Led Freq. 1500 Hz (hold 3s)
		174~179	Led Freq. 2500 Hz (hold 3s)
		180~185	Led Freq. 4000 Hz (hold 3s)
		186~191	Led Freq. 5000 Hz (hold 3s)
		192~197	Led Freq. 10000 Hz (hold 3s)
		198~203	Led Freq. 15000 Hz (hold 3s)
		204~209	Led Freq. 20000 Hz (hold 3s)
		210~215	Led Freq. 25000 Hz (hold 3s)
		216~218	Reset Pan/Tilt (Hold 3s)
		219~221	Reset only Head (Hold 3s)
		222~224	Reset All Functions (Hold 3s)
		225~234	Idle
235~237	Klingnet Disable The leds are controlled only by the wired dmx or Artnet		
238~240	Leds controled Klingnet only The leds are controlled only by the Klingnet		
241~243	Leds controled Klingnet + Dmx The leds are controlled by the Klingnet but the dmx has priority over RGBW		
244~246	Klingnet Calibration OFF So that the Klingnet white is matched with for example an Led screen, it is possible to calibrate it in the Modena calibration menu. This calibration can be activated or not from the console.		
247~249	Klingnet Calibration ON So that the Klingnet white is matched with for example an Led screen, it is possible to calibrate it in the Modena calibration menu. This calibration can be activated or not from the console		
250~252	White Calibred by IC (Hold 3s) The calibration of the White macros is controlled by a specialized IC.		
253~255	Fixed White values (Hold 3s) The value of the white macros is fixed in the software.		
12	Red	000~255	Red dimmer
13	Green	000~255	Green dimmer
14	Blue	000~255	Blue dimmer
15	White	000~255	White dimmer

Basic 16B

1	Pan	000~255	Pan
2	Pan fine	000~255	
3	Tilt	000~255	Tilt
4	Tilt fine	000~255	
5	P/T Speed	000~225	Max to min speed
		226~235	Blackout by movement
		236~255	Idle
6	Dimmer	000~255	General dimmer
7	Dimmer Fine	000~255	General dimmer fine
8	Strobe	000~009	Shutter closed
		010~019	Shutter open
		020~068	Strobe effect slow to fast
		069~79	Shutter open
		80~128	Pulse-effect in sequences
		129~139	Shutter open
		140~188	Random strobe effect slow to fast
		189~199	Shutter open
		200~248	Random flash Pixel slow to fast
		249~255	Shutter open
9	Zoom	000~255	Zoom
10	Dim Modes	000~020	Default unit setting
		021~040	Standard
		041~060	Stage
		061~080	TV
		081~100	Architectural
		101~255	Theatre
11	Control	000~005	Idle
		006~017	Invert Pan on (Hold 3s)
		018~029	Invert Pan off (Hold 3s)
		030~041	Invert Tilt on (Hold 3s)
		042~053	Invert Tilt off (Hold 3s)
		054~065	Fan Silent (Hold 3s) The fan turn always at same low speed
		066~077	Fan Auto (Hold 3s) The fan speed increase with temp
		078~089	Fan High (Hold 3s) The fan turn always at same high speed
		090~101	Linear Dimmer Curve (hold 3s)
		102~113	Square Dimmer Curve (hold 3s)
		114~125	Inv-Square Dimmer Curve (hold 3s)
		126~131	S - Dimmer Curve (hold 3s)
		132~137	Led Freq. 900 Hz (hold 3s)
		138~143	Led Freq. 1000 Hz (hold 3s)
		144~149	Led Freq. 1100 Hz (hold 3s)

11	Control	150~155	Led Freq. 1200 Hz (hold 3s)
		156~161	Led Freq. 1300 Hz (hold 3s)
		162~167	Led Freq. 1400 Hz (hold 3s)
		168~173	Led Freq. 1500 Hz (hold 3s)
		174~179	Led Freq. 2500 Hz (hold 3s)
		180~185	Led Freq. 4000 Hz (hold 3s)
		186~191	Led Freq. 5000 Hz (hold 3s)
		192~197	Led Freq. 10000 Hz (hold 3s)
		198~203	Led Freq. 15000 Hz (hold 3s)
		204~209	Led Freq. 20000 Hz (hold 3s)
		210~215	Led Freq. 25000 Hz (hold 3s)
		216~218	Reset Pan/Tilt (Hold 3s)
		219~221	Reset only Head (Hold 3s)
		222~224	Reset All Functions (Hold 3s)
		225~234	Idle
235~237	Klingnet Disable The leds are controlled only by the wired dmx or Artnet		
238~240	Leds controled Klingnet only The leds are controlled only by the Klingnet		
241~243	Leds controled Klingnet + Dmx The leds are controlled by the Klingnet but the dmx has priority over RGBW		
244~246	Klingnet Calibration OFF So that the Klingnet white is matched with for example an Led screen, it is possible to calibrate it in the Modena calibration menu. This calibration can be activated or not from the console		
247~249	Klingnet Calibration ON So that the Klingnet white is matched with for example an Led screen, it is possible to calibrate it in the Modena calibration menu. This calibration can be activated or not from the console		
250~252	White Calibred by IC (Hold 3s) The calibration of the White macros is controlled by a specialized IC.		
253~255	Fixed White values (Hold 3s) The value of the white macros is fixed in the software.		
12	Red	000~255	Red dimmer
13	Red Fine	000~255	Red dimmer fine
14	Green	000~255	Green dimmer
15	Green Fine	000~255	Green dimmer fine
16	Blue	000~255	Blue dimmer
17	Blue Fine	000~255	Blue dimmer fine
18	White	000~255	White dimmer
19	White Fine	000~255	White dimmer fine

Standard 8B

1	Pan	000~255	Pan	
2	Pan fine	000~255		
3	Tilt	000~255	Tilt	
4	Tilt fine	000~255		
5	P/T Speed	000~225	Max to min speed	
		226~235	Blackout by movement	
		236~255	Idle	
6	Dimmer	000~255	General dimmer	
7	Dimmer Fine	000~255	General dimmer fine	
8	Strobe	000~009	Shutter closed	
		010~019	shutter open	
		020~068	Strobe effect slow to fast	
		069~079	Shutter open	
		080~128	Pulse-effect in sequences	
		129~139	Shutter open	
		140~188	Random strobe effect slow to fast	
		189~199	Shutter open	
		200~248	Random flash Pixel slow to fast	
		249~255	Shutter open	
9	Virtual Wheel Color foreground	000-010	White macro RGBW channels need to be at 255 value to obtain the good color temperature. Is possible to adjust the color with RGBW	See sheet Foreground Color Wheel Page 72
		011-250	Virtual color wheel Only W channel can modify the color saturation	
		251-253	Color Wheel rotation between the color level 12 to 250	
		254-255	Color rotation backward	
10	Virtual Wheel Color Background	000-010	White macro The chosen white is obtained only when a pattern or auto program is used, Is not possible to adjust the color	See sheet Background Color Wheel Page 73
		011-251	Virtual color wheel The chosen color is obtained only when a pattern or auto program is used, Is not possible to adjust the color saturation	
		252-253	Color Wheel rotation between the color level 11 to 250	
		254-255	Color rotation backward	
11	Colour Fade/Speed	000-255	Fade between colors/ Speed from fast to slow.	

12	Patterns programs	000-009	No Program	
		010-019	Program 1	
		020-029	Program 2	
		030-039	Program 3	
		040-049	Program 4	
		050-059	Program 5	
		060-069	Program 6	
		070-079	Program 7	
		080-089	Program 8	
		090-099	Program 9	
		100-109	Program 10	
		110-119	Program 11	
		120-129	Program 12	
		130-139	Program 13	
		140-149	Program 14	
		150-159	Program 15	
		160-169	Program 16	
		170-179	Program 17	
		180-189	Program 18	
		190-199	Program 19	
200-209	Program 20			
210-219	Klingnet only enable			
220-255	Klingnet + RGBW channels enable			
13	Patterns Programs manual step	000 - 004	Static step 1	Select one of the 8 steps of the selected program 12.
		005 - 009	Static step 2	
		010 - 014	Static step 3	
		015 - 019	Static step 4	
		020 - 024	Static step 5	
		025 - 029	Static step 6	
		030 - 034	Static step 7	
		035 - 039	Static step 8	
	Patterns Programs auto step	040 - 145	Chase Forward F > S	Speed of 8 steps chaser
		146 - 149	Stop	
150 - 255		Chase Backward S > F		
14	Programs Fade	000	Normal	
		001-255	Fast to slow speed	
15	Zoom	000~255	Zoom	

16	Dim Modes	000~020	Default unit setting
		021~040	Standard
		041~060	Stage
		061~080	TV
		081~100	Architectural
		101~255	Theatre
17	Control	000~005	Idle
		006~017	Invert Pan on (Hold 3s)
		018~029	Invert Pan off (Hold 3s)
		030~041	Invert Tilt on (Hold 3s)
		042~053	Invert Tilt off (Hold 3s)
		054~065	Fan Silent (Hold 3s) The fan turns always at same low speed
		066~077	Fan Auto (Hold 3s) The fan speed increase with temp.
		078~089	Fan High (Hold 3s) The fan turns always at same high speed
		090~101	Linear Dimmer Curve (hold 3s)
		102~113	Square Dimmer Curve (hold 3s)
		114~125	Inv-Square Dimmer Curve (hold 3s)
		126~131	S - Dimmer Curve (hold 3s)
		132~137	Led Freq. 900 Hz (hold 3s)
		138~143	Led Freq. 1000 Hz (hold 3s)
		144~149	Led Freq. 1100 Hz (hold 3s)
		150~155	Led Freq. 1200 Hz (hold 3s)
		156~161	Led Freq. 1300 Hz (hold 3s)
		162~167	Led Freq. 1400 Hz (hold 3s)
		168~173	Led Freq. 1500 Hz (hold 3s)
		174~179	Led Freq. 2500 Hz (hold 3s)
180~185	Led Freq. 4000 Hz (hold 3s)		
186~191	Led Freq. 5000 Hz (hold 3s)		

17	Control	192~197	Led Freq. 10000 Hz (hold 3s)
		198~203	Led Freq. 15000 Hz (hold 3s)
		204~209	Led Freq. 20000 Hz (hold 3s)
		210~215	Led Freq. 25000 Hz (hold 3s)
		216~218	Reset Pan/Tilt (Hold 3s)
		219~221	Reset only Head (Hold 3s)
		222~224	Reset All Functions (Hold 3s)
		225~234	Idle
		235~237	Klingnet Disable The leds are controlled only by the wired dmx or Artnet
		238~240	Leds controled Klingnet only The leds are controlled only by the Klingnet
		241~243	Leds controled Klingnet + Dmx The leds are controlled by the Klingnet but the dmx has priority over RGBW
		244~246	Klingnet Calibration OFF So that the Klingnet white is matched with for example an Led screen, it is possible to calibrate it in the Modena calibration menu. This calibration can be activated or not from the console
247~249	Klingnet Calibration ON So that the Klingnet white is matched with for example an Led screen, it is possible to calibrate it in the Modena calibration menu. This calibration can be activated or not from the console		
250~252	White Calibred by IC (Hold 3s) The calibration of the White macros is controlled by a specialized IC.		
253~255	Fixed White values (Hold 3s) The value of the white macros is fixed in the software.		
18	Red	000~255	Red dimmer
19	Green	000~255	Green dimmer
20	Blue	000~255	Blue dimmer
21	White	000~255	White dimmer



Mode Standard 16B

1	Pan	000~255	Pan	
2	Pan fine	000~255		
3	Tilt	000~255	Tilt	
4	Tilt fine	000~255		
5	P/T Speed	000~225	Max to min speed	
		226~235	Blackout by movement	
		236~255	Idle	
6	Dimmer	000~255	General dimmer	
7	Dimmer Fine	000~255	General dimmer fine	
8	Strobe	000~009	Shutter closed	
		010~019	shutter open	
		020~068	Strobe effect slow to fast	
		069~079	Shutter open	
		080~128	Pulse-effect in sequences	
		129~139	Shutter open	
		140~188	Random strobe effect slow to fast	
		189~199	Shutter open	
		200~248	Random flash Pixel slow to fast	
249~255	Shutter open			
9	Virtual Wheel Color foreground	000-010	White macro RGBW channels need to are at 255 value to obtain the good color temperature. Is possible to ajust the color with RGBW	See sheet Forground Color Wheel Page 72
		011-250	Virtual color wheel Only W channel can modify the color saturation	
		251-253	Color Wheel rotation between the color level 12 to 250	
		254-255	Color rotation backward	
10	Virtual Wheel Color Background	000-010	White macro The chosen white is obtained only when a patern or auto program is used, Is not possible to adjust the color	See sheet Background Color Wheel Page 73
		011-251	Virtual color wheel The chosen color is obtained only when a patern or auto program is used, Is not possible to adjust the color saturation	
		252-253	Color Wheel rotation between the color level 11 to 250	
		254-255	Color rotation backward	
11	Colour Fade/Speed	000-255	Fade between colors/ Speed from fast to slow.	

12	Patterns programs	000-009	No Program	
		010-019	Program 1	
		020-029	Program 2	
		030-039	Program 3	
		040-049	Program 4	
		050-059	Program 5	
		060-069	Program 6	
		070-079	Program 7	
		080-089	Program 8	
		090-099	Program 9	
		100-109	Program 10	
		110-119	Program 11	
		120-129	Program 12	
		130-139	Program 13	
		140-149	Program 14	
		150-159	Program 15	
		160-169	Program 16	
		170-179	Program 17	
		180-189	Program 18	
		190-199	Program 19	
200-209	Program 20			
210-219	Klingnet only enable			
220-255	Klingnet + RGBW channels enable			
13	Patterns Programs manual step	000 - 004	Static step 1	Select one of the 8 steps of the selected program 12.
		005 - 009	Static step 2	
		010 - 014	Static step 3	
		015 - 019	Static step 4	
		020 - 024	Static step 5	
		025 - 029	Static step 6	
		030 - 034	Static step 7	
		035 - 039	Static step 8	
	Patterns Programs auto step	040 - 145	Chase Forward F > S	Speed of 8 steps chaser
		146 - 149	Stop	
150 - 255		Chase Backward S > F		
14	Programs Fade	000	Normal	
		001-255	Fast to slow speed	
15	Zoom	000~255	Zoom	

16	Dim Modes	000~020	Default unit setting
		021~040	Standard
		041~060	Stage
		061~080	TV
		081~100	Aritectural
		101~255	Theatre
17	Control	000~005	Idle
		006~017	Invert Pan on (Hold 3s)
		018~029	Invert Pan off (Hold 3s)
		030~041	Invert Tilt on (Hold 3s)
		042~053	Invert Tilt off (Hold 3s)
		054~065	Fan Silent (Hold 3s) The fan turn always at same low speed
		066~077	Fan Auto (Hold 3s) The fan speed increase with temp.
		078~089	Fan High (Hold 3s) The fan turn always at same high speed
		090~101	Linear Dimmer Curve (hold 3s)
		102~113	Square Dimmer Curve (hold 3s)
		114~125	Inv-Square Dimmer Curve (hold 3s)
		126~131	S - Dimmer Curve (hold 3s)
		132~137	Led Freq. 900 Hz (hold 3s)
		138~143	Led Freq. 1000 Hz (hold 3s)
		144~149	Led Freq. 1100 Hz (hold 3s)
		150~155	Led Freq. 1200 Hz (hold 3s)
		156~161	Led Freq. 1300 Hz (hold 3s)
		162~167	Led Freq. 1400 Hz (hold 3s)
		168~173	Led Freq. 1500 Hz (hold 3s)
		174~179	Led Freq. 2500 Hz (hold 3s)
180~185	Led Freq. 4000 Hz (hold 3s)		
186~191	Led Freq. 5000 Hz (hold 3s)		

17	Control	192~197	Led Freq. 10000 Hz (hold 3s)
		198~203	Led Freq. 15000 Hz (hold 3s)
		204~209	Led Freq. 20000 Hz (hold 3s)
		210~215	Led Freq. 25000 Hz (hold 3s)
		216~218	Reset Pan/Tilt (Hold 3s)
		219~221	Reset only Head (Hold 3s)
		222~224	Reset All Functions (Hold 3s)
		225~234	Idle
		235~237	Klingnet Disable The leds are controlled only by the wired dmx or Artnet
		238~240	Leds controled Klingnet only The leds are controlled only by the Klingnet
241~243	Leds controled Klingnet + Dmx The leds are controlled by the Klingnet but the dmx has priority over RGBW		
244~246	Klingnet Calibration OFF So that the Klingnet white is matched with for example an Led screen, it is possible to calibrate it in the Modena calibration menu. This calibration can be activated or not from the console		
247~249	Klingnet Calibration ON So that the Klingnet white is matched with for example an Led screen, it is possible to calibrate it in the Modena calibration menu. This calibration can be activated or not from the console		
250~252	White Calibred by IC (Hold 3s) The calibration of the White macros is controlled by a specialized IC.		
253~255	Fixed White values (Hold 3s) The value of the white macros is fixed in the software..		
18	Red	000~255	Red dimmer
19	Red Fine	000~255	Red dimmer Fine
20	Green	000~255	Green dimmer
21	Green Fine	000~255	Green dimmer Fine
22	Blue	000~255	Blue dimmer
23	Blue Fine	000~255	Blue dimmer Fine
24	White	000~255	White dimmer
25	White Fine	000~255	White dimmer Fine



Mode Pixel 8B

1	Pan	000~255	Pan	
2	Pan fine	000~255		
3	Tilt	000~255	Tilt	
4	Tilt fine	000~255		
5	P/T Speed	000~225	Max to min speed	
		226~235	Blackout by movement	
		236~255	Idle	
6	Dimmer	000~255	General dimmer	
7	Dimmer Fine	000~255	General dimmer fine	
8	Strobe	000~009	Shutter closed	
		010~019	shutter open	
		020~068	Strobe effect slow to fast	
		069~079	Shutter open	
		080~128	Pulse-effect in sequences	
		129~139	Shutter open	
		140~188	Random strobe effect slow to fast	
		189~199	Shutter open	
		200~248	Random flash Pixel slow to fast	
		249~255	Shutter open	
9	Virtual Wheel Color	000-010	White macro RGBW channels need to are at 255 value to obtain the good color temperature. Is possible to ajust the color with RGBW	See sheet Forground Color Wheel Page 72
		011-250	Virtual color wheel Only W channel can modify the color saturation	
		251-253	Color Wheel rotation between the color level 12 to 250	
		254-255	Color rotation backward	
10	Colour Fade/Speed	000-255	Fade between colors/ Speed from fast to slow.	
11	Zoom	000~255	Zoom	
12	Dim Modes	000~020	Default unit setting	
		021~040	Standard	
		041~060	Stage	
		061~080	TV	
		081~100	Aritectural	
		101~255	Theatre	

13	Control	000~005	Idle
		006~017	Invert Pan on (Hold 3s)
		018~029	Invert Pan off (Hold 3s)
		030~041	Invert Tilt on (Hold 3s)
		042~053	Invert Tilt off (Hold 3s)
		054~065	Fan Silent (Hold 3s) The fan turn always at same low speed
		066~077	Fan Auto (Hold 3s) The fan speed increase with temp.
		078~089	Fan High (Hold 3s) The fan turn always at same high speed
		090~101	Linear Dimmer Curve (hold 3s)
		102~113	Square Dimmer Curve (hold 3s)
		114~125	Inv-Square Dimmer Curve (hold 3s)
		126~131	S - Dimmer Curve (hold 3s)
		132~137	Led Freq. 900 Hz (hold 3s)
		138~143	Led Freq. 1000 Hz (hold 3s)
		144~149	Led Freq. 1100 Hz (hold 3s)
		150~155	Led Freq. 1200 Hz (hold 3s)
		156~161	Led Freq. 1300 Hz (hold 3s)
		162~167	Led Freq. 1400 Hz (hold 3s)
		168~173	Led Freq. 1500 Hz (hold 3s)
		174~179	Led Freq. 2500 Hz (hold 3s)
		180~185	Led Freq. 4000 Hz (hold 3s)
		186~191	Led Freq. 5000 Hz (hold 3s)
		192~197	Led Freq. 10000 Hz (hold 3s)
		198~203	Led Freq. 15000 Hz (hold 3s)
		204~209	Led Freq. 20000 Hz (hold 3s)
		210~215	Led Freq. 25000 Hz (hold 3s)
		216~218	Reset Pan/Tilt (Hold 3s)
		219~221	Reset only Head (Hold 3s)
		222~224	Reset All Functions (Hold 3s)
		225~234	Idle
		235~237	Klingnet Disable The leds are controlled only by the wired dmx or Artnet
		238~240	Leds controled Klingnet only The leds are controlled only by the Klingnet
241~243	Leds controled Klingnet + Dmx The leds are controlled by the Klingnet but the dmx has priority over RGBW		
244~246	Klingnet Calibration OFF So that the Klingnet white is matched with for example an Led screen, it is possible to calibrate it in the Modena calibration menu. This calibration can be activated or not from the console		

13	Control	247~249	Klingnet Calibration ON So that the Klingnet white is matched with for example an Led screen, it is possible to calibrate it in the Modena calibration menu. This calibration can be activated or not from the console
		250~252	White Calibred by IC (Hold 3s) The calibration of the White macros is controlled by a specialized IC.
		253~255	Fixed White values (Hold 3s) The value of the white macros is fixed in the software.
14	Red 1	000~255	Red 1 dimmer
15	Green 1	000~255	Green 1 dimmer
16	Blue 1	000~255	Blue 1 dimmer
17	White 1	000~255	White 1 dimmer
18	Red 2	000~255	Red 2 dimmer
19	Green 2	000~255	Green 2 dimmer
20	Blue 2	000~255	Blue 2 dimmer
21	White 2	000~255	White 2 dimmer
22	Red 3	000~255	Red 3 dimmer
23	Green 3	000~255	Green 3 dimmer
24	Blue 3	000~255	Blue 3 dimmer
25	White 3	000~255	White 3 dimmer
26	Red 4	000~255	Red 4 dimmer
27	Green 4	000~255	Green 4 dimmer
28	Blue 4	000~255	Blue 4 dimmer
29	White 4	000~255	White 4 dimmer
30	Red 5	000~255	Red 5 dimmer
31	Green 5	000~255	Green 5 dimmer
32	Blue 5	000~255	Blue 5 dimmer
33	White 5	000~255	White 5 dimmer
34	Red 6	000~255	Red 6 dimmer
35	Green 6	000~255	Green 6 dimmer
36	Blue 6	000~255	Blue 6 dimmer
37	White 6	000~255	White 6 dimmer
38	Red 7	000~255	Red 7 dimmer
39	Green 7	000~255	Green 7 dimmer
40	Blue 7	000~255	Blue 7 dimmer
41	White 7	000~255	White 7 dimmer

Mode Pixel 16B

1	Pan	000~255	Pan	
2	Pan fine	000~255		
3	Tilt	000~255	Tilt	
4	Tilt fine	000~255		
5	P/T Speed	000~225	Max to min speed	
		226~235	Blackout by movement	
		236~255	Idle	
6	Dimmer	000~255	General dimmer	
7	Dimmer Fine	000~255	General dimmer fine	
8	Strobe	000~009	Shutter closed	
		010~019	shutter open	
		020~068	Strobe effect slow to fast	
		069~079	Shutter open	
		080~128	Pulse-effect in sequences	
		129~139	Shutter open	
		140~188	Random strobe effect slow to fast	
		189~199	Shutter open	
		200~248	Random flash Pixel slow to fast	
		249~255	Shutter open	
9	Virtual Wheel Color	000-010	White macro RGBW annels need to are at 255 value to obtain the good color temperature. Is possible to ajust the color with RGBW	See sheet Forground Color Wheel Page 72
		011-250	Virtual color wheel Only W annel can modify the color saturation	
		251-253	Color Wheel rotation between the color level 12 to 250	
		254-255	Color rotation backward	
10	Colour Fade/ Speed	000-255	Fade between colors/ Speed from fast to slow.	
11	Zoom	000~255	Zoom	
12	Dim Modes	000~020	Default unit setting	
		021~040	Standard	
		041~060	Stage	
		061~080	TV	
		081~100	Aritectural	
		101~255	Theatre	

13	Control	000~005	Idle
		006~017	Invert Pan on (Hold 3s)
		018~029	Invert Pan off (Hold 3s)
		030~041	Invert Tilt on (Hold 3s)
		042~053	Invert Tilt off (Hold 3s)
		054~065	Fan Silent (Hold 3s) The fan turn always at same low speed
		066~077	Fan Auto (Hold 3s) The fan speed increase with temp.
		078~089	Fan High (Hold 3s) The fan turn always at same high speed
		090~101	Linear Dimmer Curve (hold 3s)
		102~113	Square Dimmer Curve (hold 3s)
		114~125	Inv-Square Dimmer Curve (hold 3s)
		126~131	S - Dimmer Curve (hold 3s)
		132~137	Led Freq. 900 Hz (hold 3s)
		138~143	Led Freq. 1000 Hz (hold 3s)
		144~149	Led Freq. 1100 Hz (hold 3s)
		150~155	Led Freq. 1200 Hz (hold 3s)
		156~161	Led Freq. 1300 Hz (hold 3s)
		162~167	Led Freq. 1400 Hz (hold 3s)
		168~173	Led Freq. 1500 Hz (hold 3s)
		174~179	Led Freq. 2500 Hz (hold 3s)
		180~185	Led Freq. 4000 Hz (hold 3s)
		186~191	Led Freq. 5000 Hz (hold 3s)
		192~197	Led Freq. 10000 Hz (hold 3s)
		198~203	Led Freq. 15000 Hz (hold 3s)
		204~209	Led Freq. 20000 Hz (hold 3s)
		210~215	Led Freq. 25000 Hz (hold 3s)
		216~218	Reset Pan/Tilt (Hold 3s)
		219~221	Reset only Head (Hold 3s)
		222~224	Reset All Functions (Hold 3s)
		225~234	Idle
		235~237	Klingnet Disable The leds are controlled only by the wired dmx or Artnet
		238~240	Leds controled Klingnet only The leds are controlled only by the Klingnet
241~243	Leds controled Klingnet + Dmx The leds are controlled by the Klingnet but the dmx has priority over RGBW		
244~246	Klingnet Calibration OFF So that the Klingnet white is matched with for example an Led screen, it is possible to calibrate it in the Modena calibration menu. This calibration can be activated or not from the console		

13	Control	247~249	Klingnet Calibration ON So that the Klingnet white is matched with for example an Led screen, it is possible to calibrate it in the Modena calibration menu. This calibration can be activated or not from the console
		250~252	White Calibred by IC (Hold 3s) The calibration of the White macros is controlled by a specialized IC.
		253~255	Fixed White values (Hold 3s) The value of the white macros is fixed in the software.
14	Red 1	000~255	Red 1 dimmer
15	Red 1 Fine	000~255	Red 1 dimmer Fine
16	Green 1	000~255	Green 1 dimmer
17	Green 1 Fine	000~255	Green 1 dimmer Fine
18	Blue 1	000~255	Blue 1 dimmer
19	Blue 1 Fine	000~255	Blue 1 dimmer Fine
20	White 1	000~255	White 1 dimmer
21	White 1 Fine	000~255	White 1 dimmer Fine
22	Red 2	000~255	Red 2 dimmer
23	Red 2 Fine	000~255	Red 2 dimmer Fine
24	Green 2	000~255	Green 2 dimmer
25	Green 2 Fine	000~255	Green 2 dimmer Fine
26	Blue 2	000~255	Blue 2 dimmer
27	Blue 2 Fine	000~255	Blue 2 dimmer Fine
28	White 2	000~255	White 2 dimmer
29	White 2 Fine	000~255	White 2 dimmer Fine
30	Red 3	000~255	Red 3 dimmer
31	Red 3 Fine	000~255	Red 3 dimmer Fine
32	Green 3	000~255	Green 3 dimmer
33	Green 3 Fine	000~255	Green 3 dimmer Fine
34	Blue 3	000~255	Blue 3 dimmer
35	Blue 3 Fine	000~255	Blue 3 dimmer Fine
36	White 3	000~255	White 3 dimmer
37	White 3 Fine	000~255	White 3 dimmer Fine
38	Red 4	000~255	Red 4 dimmer
39	Red 4 Fine	000~255	Red 4 dimmer Fine
40	Green 4	000~255	Green 4 dimmer
41	Green 4 Fine	000~255	Green 4 dimmer Fine
42	Blue 4	000~255	Blue 4 dimmer
43	Blue 4 Fine	000~255	Blue 4 dimmer Fine
44	White 4	000~255	White 4 dimmer
45	White 4 Fine	000~255	White 4 dimmer Fine
46	Red 5	000~255	Red 5 dimmer
47	Red 5 Fine	000~255	Red 5 dimmer Fine
48	Green 5	000~255	Green 5 dimmer

49	Green 5 Fine	000~255	Green 5 dimmer Fine
50	Blue 5	000~255	Blue 5 dimmer
51	Blue 5 Fine	000~255	Blue 5 dimmer Fine
52	White 5	000~255	White 5 dimmer
53	White 5 Fine	000~255	White 5 dimmer Fine
54	Red 6	000~255	Red 6 dimmer
55	Red 6 Fine	000~255	Red 6 dimmer Fine
56	Green 6	000~255	Green 6 dimmer
57	Green 6 Fine	000~255	Green 6 dimmer Fine
58	Blue 6	000~255	Blue 6 dimmer
59	Blue 6 Fine	000~255	Blue 6 dimmer Fine
60	White 6	000~255	White 6 dimmer
61	White 6 Fine	000~255	White 6 dimmer Fine
62	Red 7	000~255	Red 7 dimmer
63	Red 7 Fine	000~255	Red 7 dimmer Fine
64	Green 7	000~255	Green 7 dimmer
65	Green 7 Fine	000~255	Green 7 dimmer Fine
66	Blue 7	000~255	Blue 7 dimmer
67	Blue 7 Fine	000~255	Blue 7 dimmer Fine
68	White 7	000~255	White 7 dimmer
69	White 7 Fine	000~255	White 7 dimmer Fine

FOREGROUND VIRTUAL COLOR WHEEL TABLE

DMX	Couleur	
0	RGBW max	
1	White 10000° K	
2	White 8000° K	
3	White 6500° K	
4	White 5600° K	
5	White 5000° K	
6	White 4500° K	
7	White 4000° K	
8	White 3200° K	
9	White 3000° K	
10	White 2700° K	
11	Red	
↕		
51		Yellow
↕		
91		Green
↕		
171		Blue
↕		
211		Magenta
↕		
251		Red
252	CW Color Wheel Rotation	
253		
254	CCW Color Wheel Rotation	
255		

BACKGROUND VIRTUAL COLOR WHEEL TABLE

DMX	Couleur
0	No Background
1	White 10000° K
2	White 8000° K
3	White 6500° K
4	White 5600° K
5	White 5000° K
6	White 4500° K
7	White 4000° K
8	White 3200° K
9	White 3000° K
10	White 2700° K
11	Red
↕	
51	Yellow
↕	
91	Green
↕	
171	Blue
↕	
211	Magenta
↕	
251	Red
252	CW Color Wheel Rotation
253	
254	CCW Color Wheel Rotation
255	

THE RGBW CHANNELS HAVE NO ACTION ON THIS VIRTUAL COLOR WHEEL SINCE THEY ONLY CONTROL THE FOREGROUND.

STARWAY

22 Rue Edouard Buffard
77144 MONTEVRAIN
France
Tél. : +33 (0)820 230 007

